

PRESCHOOL

letter of the week

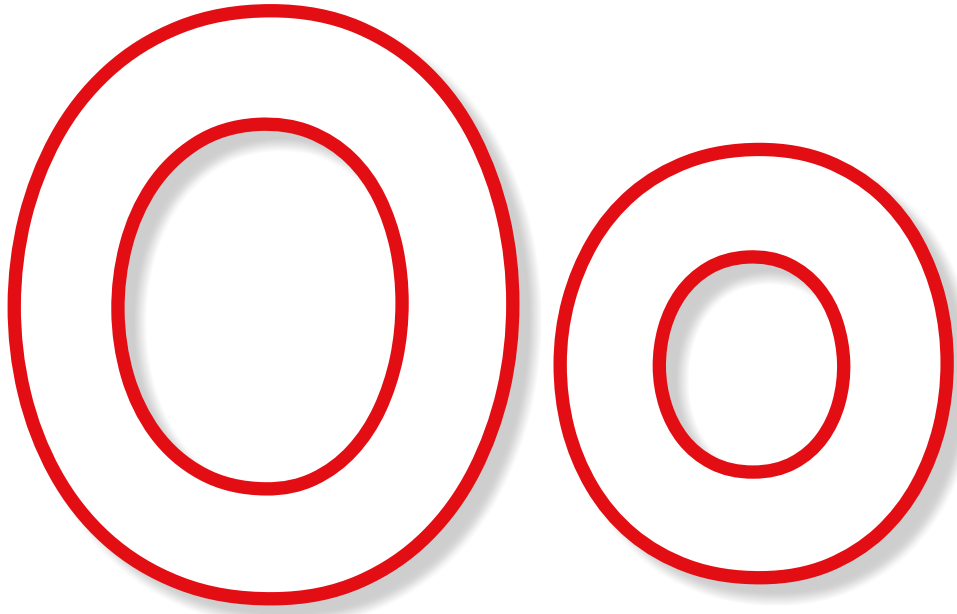

posters

7 activities

15 worksheets

certificate

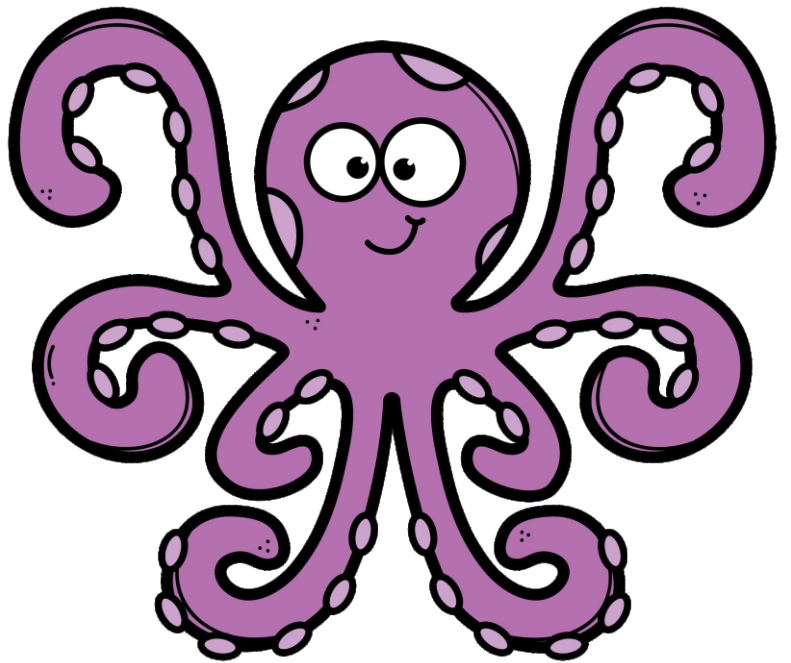

Lavinia Pop

Thank you for downloading this product; I hope you will enjoy using it and that it will be a valuable resource for you! I value your feedback, so please don't hesitate to contact me if you have any concerns whatsoever as I will endeavour to address them. And if you like what I've done, please let me know by leaving feedback at my online store :)

Lavinia

lavinia@kinder-resources.com

ILLUSTRATIONS Kari Bolt, Little Red, Hidesy's Clipart, Dancing Crayon Designs, Whimsy Clips, PartyHead Graphics, Ramona Majdis, Zip-a-Dee-doo-dah-Designs, Bunny on a Cloud, Krista Wallden - Creative Clips, Creating4 the Classroom, Rainbow Sprinkle Studio - Sasha Mitten, First Class Clipart, Erin Colleen Design

teacherspayteachers.com/Store/Kari-Bolt teacherspayteachers.com/Store/Littered teacherspayteachers.com/Store/Hidesys-Clipart
dancingcrayon.com teacherspayteachers.com/Store/Whimsy-Clips teacherspayteachers.com/Store/Partyhead-Graphics
teacherspayteachers.com/Store/Ramona-Majdis teacherspayteachers.com/Store/Zip-a-dee-doo-dah-Designs
teacherspayteachers.com/Store/Bunny-On-A-Cloud teacherspayteachers.com/Store/Krista-Wallden-Creative-Clips
teacherspayteachers.com/Store/Creating4-The-Classroom teacherspayteachers.com/Store/Rainbow-Sprinkle-Studio-Sasha-Mitten
teacherspayteachers.com/Store/First-Class-Clipart teacherspayteachers.com/Store/Erin-Colleen-Design

This packet contains Images used under license from Shutterstock.com

FONTS schoolfonts.com.au teacherspayteachers.com/Store/Kimberly-Geswein-Fonts
teacherspayteachers.com/Store/Ramonam-Graphics

PRINTING TIP This resource has been designed for printing on A4-sized paper. If you are printing on a different size, select "shrink to printable area" or "print to fit page" (or a similar option) in order for the contents of this unit to print correctly.

Copyright © 2023 by Lavinia Pop - All rights reserved by author.

Purchase of this item entitles the purchaser the right to reproduce the pages for personal and classroom use. Duplication for other classes, an entire school or commercial purposes is strictly prohibited without written permission from the author. Minor editing is permitted only for personal use, however the document remains under copyright even when edited. Posting this item in whole or in part on the Internet in any form is strictly prohibited and is a violation of the Digital Millennium Copyright Act (DMCA).

Please be fair and don't share! If you are not the original purchaser of this file, please visit my store to purchase a copy. Kinder-Resources.com

let's connect!



Kinder-Resources.com



facebook.com/inmyworldlavinipop



instagram.com/inmyworld_lavinipop



pinterest.com/lavinipop

Introduction

About this book

This Letter of the Week unit has been designed to be used with children in Preschool. Included are a variety of games, activities and worksheets that will help teach correct letter formation, letter identification and recognition of letter sound.

Contents and directions for use

1. Alphabet poster

To prepare the poster for use, print, laminate and display on your wall.

2. Alphabet poster with pictures and words

To prepare the poster for use, print, laminate and display on your wall.

3. Word Wall cards

To prepare the cards for use, print, laminate and display your choice of words on your wall. Alternatively, make a hole on the corner of each card and secure them together with a key ring.

4. Letter and picture puzzles

To prepare for use, print, laminate and cut puzzles pieces apart. Children will match the puzzles pieces together.

5. Word puzzles

To prepare for use, print, laminate and cut puzzles pieces apart. Children will place the puzzle pieces in order to reveal the picture and word.

6. Alphabet Find and Letter Match

To prepare for use, print, laminate and cut the cards. Provide children with counters to show their answers.

For the Alphabet Find cards, children will find the matching letter and place a counter on it. For the Letter Match cards, children will find all the letters that match the focus letter.

7. Beginning Sounds Wheel

To prepare for use, print, laminate and cut the cards. Provide children with pegs or another clipping device to show their answers.

Children will say the word for each picture and clip a peg on the ones that start with the focus letter sound.

8. Upper and lower case letter tracing cards with correct letter formation

To prepare for use, print, laminate and cut the cards apart. Provide children with erasable markers and or/play dough.

Children will practice tracing the letters on the cards and forming them with play dough.

9. Alphabet tracing cards with pre-writing strokes

To prepare for use, print, laminate and cut the cards apart. Use a hole punch to make a hole in each of the 4 cards and then use a key ring, or similar device, to secure the cards together. Provide children with erasable markers.

Children will practice tracing the pre-writing strokes and letters on the cards.

10. Alphabet booklets (color and black and white)

To prepare for use, print and cut the cards apart. Use a hole punch to make a hole in each of the 4 cards and then use a key ring, or similar device, to secure the cards together. Alternatively, staple the pages together.

Children will practice reading the predictable sentence, “(focus letter) is for...”

11. Alphabet bracelets

Children will color the pictures and focus letters on their bracelet and then secure it to their wrist with sticky tape.

12. Cutting Practice

Children will color the picture and focus letters, then cut around the shape. This can then be glued onto a piece of paper or used to decorate the room.

13. Colouring page

Children will color the pictures that begin with the focus letter.

14. Pre-Writing Tracing Practice

Children will trace the lines from upper case letter to lower case letter.

15. Alphabet Cut and Glue

Children will color the pictures and glue them onto the dots.

16. Beginning Sounds Scene

Children will color the pictures, cut them out and glue them onto the scene. They can use the pictures to tell a story.

17. Dot painting

Children will color the pictures, then use a cotton dipped in paint to fill in the circles.

18. Upper Case Letter Tracing

Children will trace the writing strokes that make the upper case letter, then they will trace the upper case letter.

19. Lower Case Letter Tracing

Children will trace the writing strokes that make the lower case letter, then they will trace the lower case letter.

20. Letter Sorting

Children will color the pictures, then cut out the letters from the bottom of the page and glue them into the correct windows.

21. Color by Code

Children will color the sections of the picture using the code.

22. Beginning Sounds (upper case letter)

Children will trace the letters, then color the pictures that start with the focus letter sound. (Two versions of this page are included: one with pictures beginning with ONLY the focus letter and another with mixed beginning sound pictures.)

23. Beginning Sounds (lower case letter)

Children will trace the letters, then color the pictures that start with the focus letter sound. (Two versions of this page are included: one with pictures beginning with ONLY the focus letter and another with mixed beginning sound pictures.)

24. Missing Letters

Children will trace the words and color the pictures. They will then cut out the lower case letters from the bottom of the page and glue them into the empty boxes.

25. I Know the Letter Certificate

Print certificate and present to student at the end of the week or letter study.

26. Letter Craft (for upper case and lower case letters)

Children will cut out the different pieces and glue them on the following page to make the craft.

Happy Teaching :)

Oo

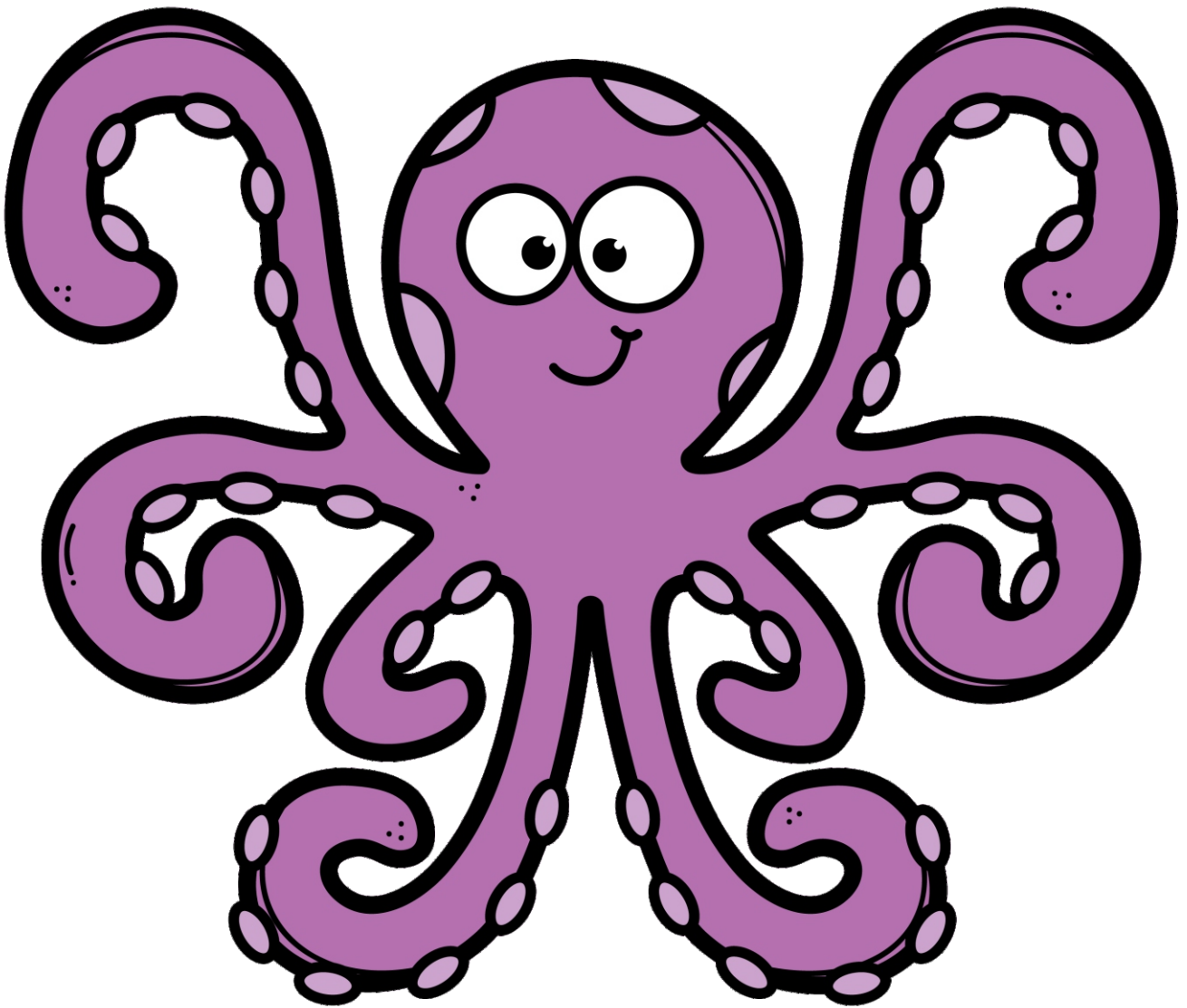

octopus

Oo

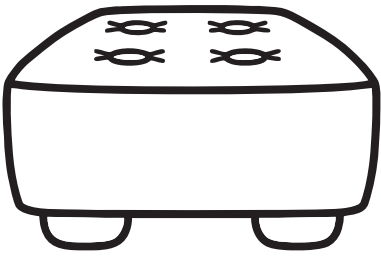

ottoman

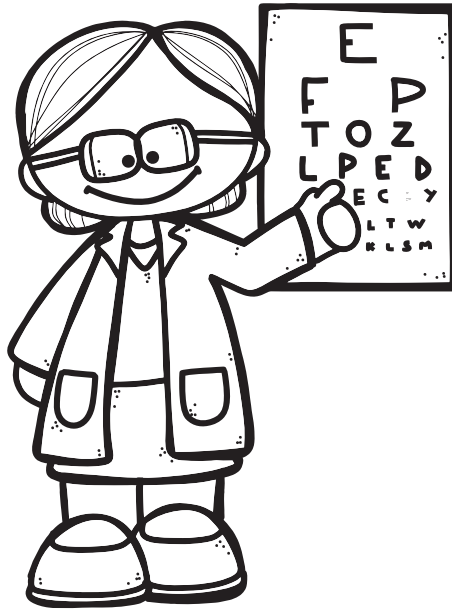

optometrist

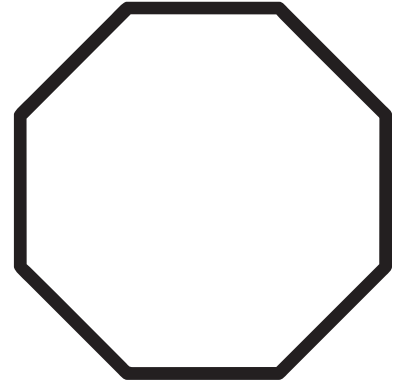

octagon

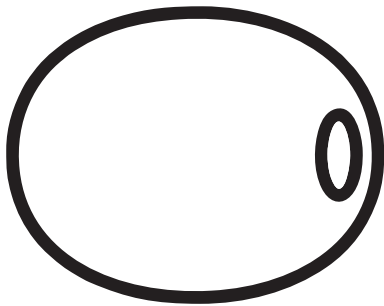

olive

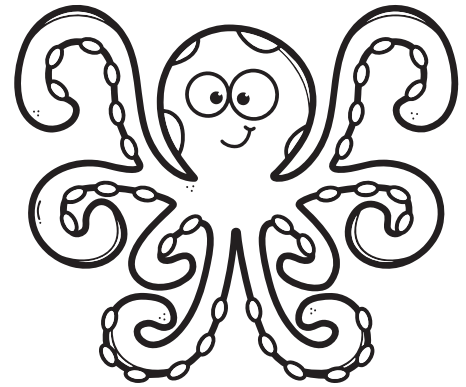

octopus



onion



otter

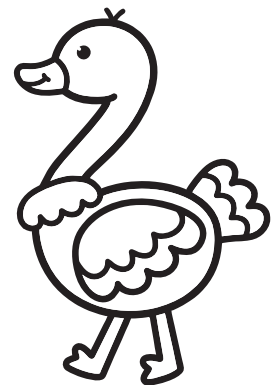

ostrich

Name:



Upper Case Letter Tracing

Trace the strokes and then the letters.

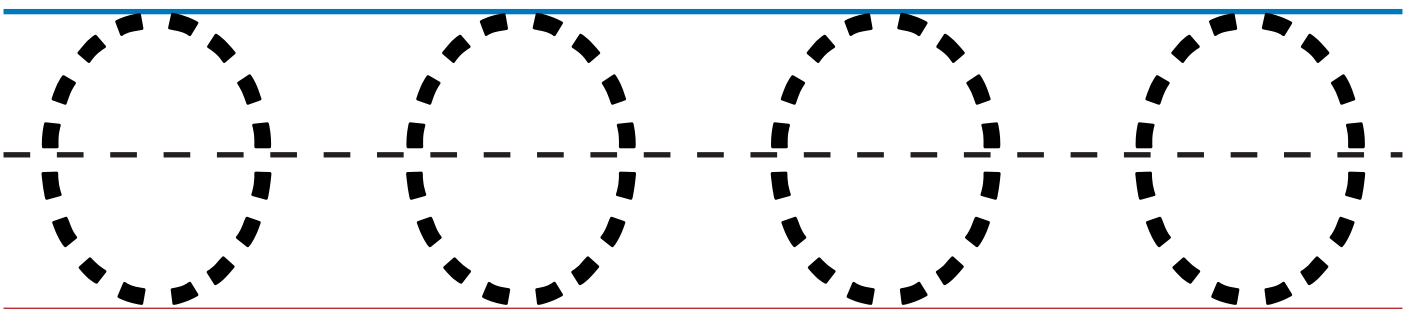
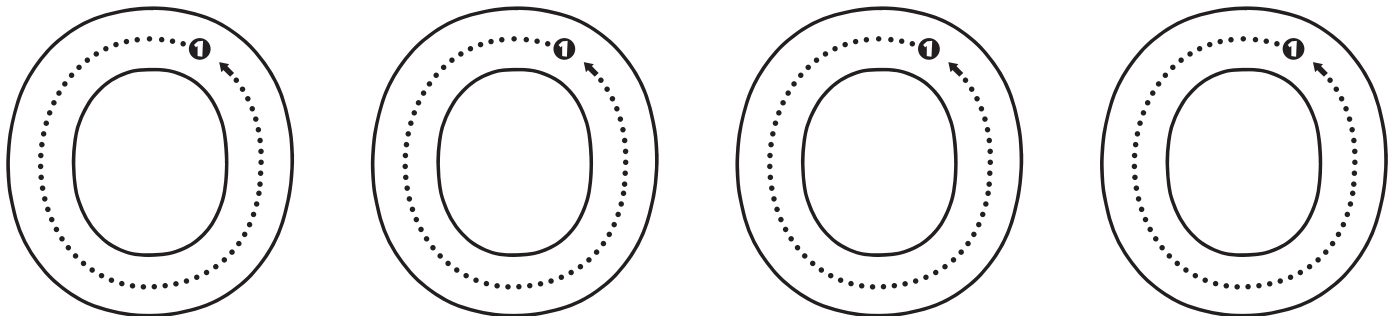
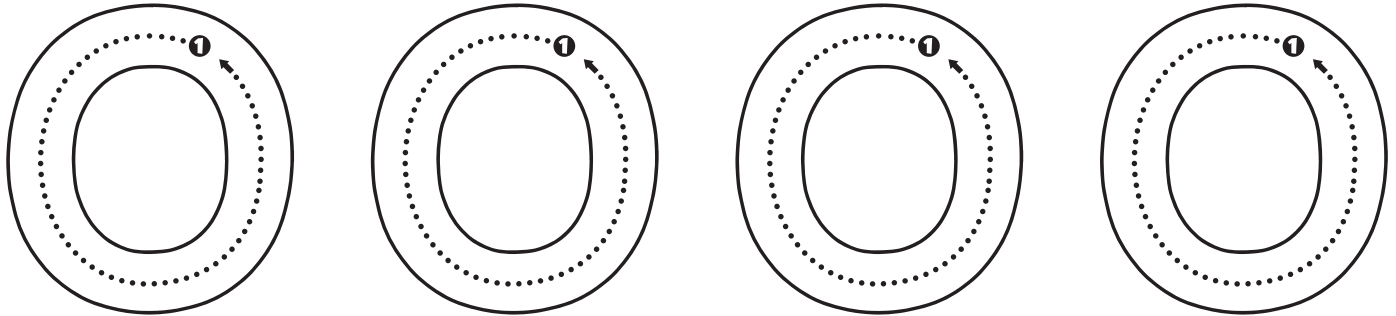
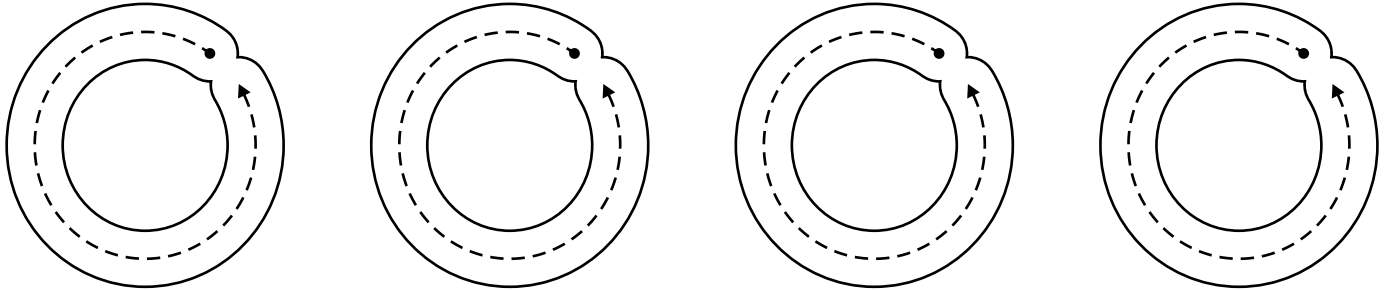

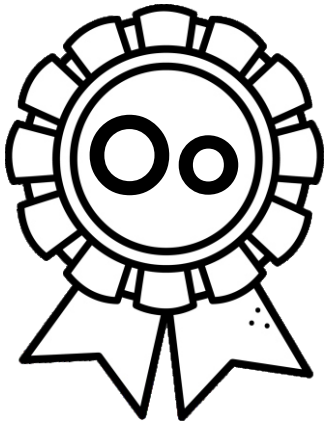

I know the letter

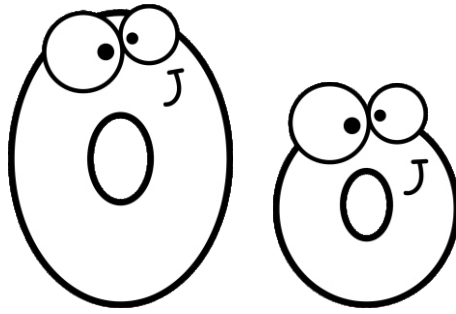

Presented to

Signed

Date

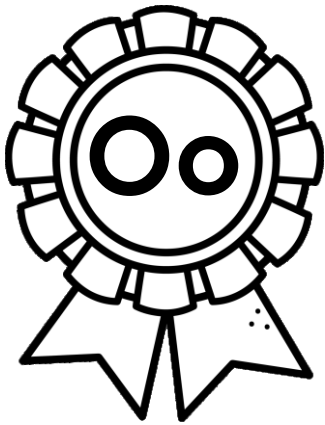

I know the letter

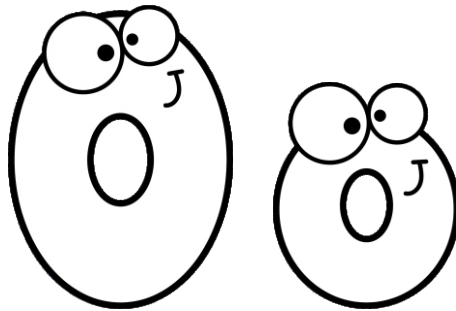

Presented to

Signed

Date