

# Construction PRESCHOOL WORKSHEETS & ACTIVITIES

Name: \_\_\_\_\_

## Matching Halves

Cut and paste the pieces to complete each picture.

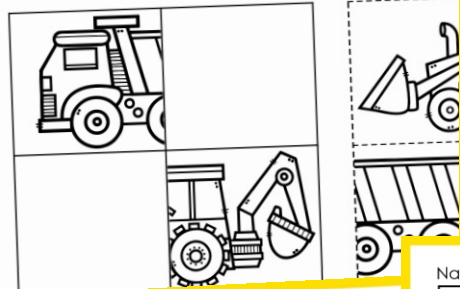

Name: \_\_\_\_\_

## Patterns AB

Cut and paste the pictures in the empty boxes to complete each pattern.

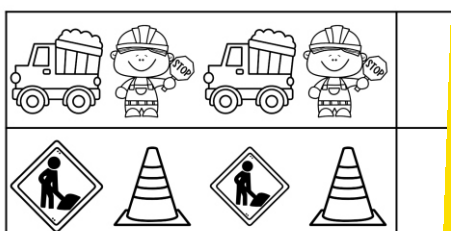

Name: \_\_\_\_\_

## Missing Numbers

Cut and paste the missing numbers to complete the number sequence.

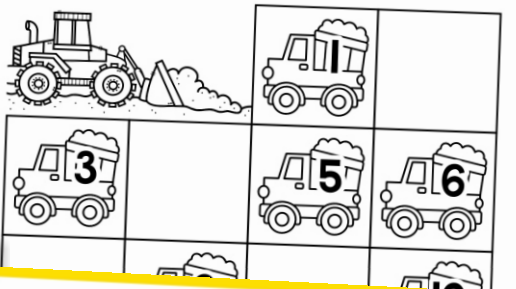

Name: \_\_\_\_\_

## What is Different?

Circle the picture that is different.

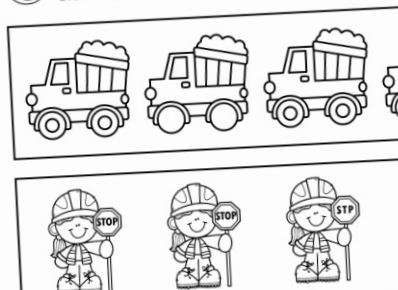

Name: \_\_\_\_\_

## Number Match 1

Cut and paste the numbers in the correct box.

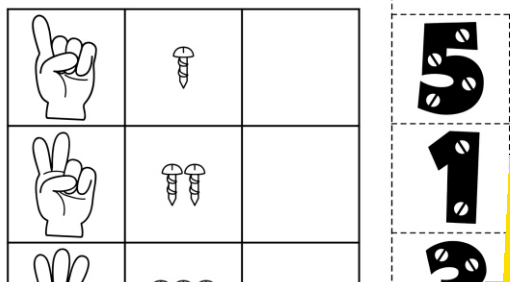

Name: \_\_\_\_\_

## Alphabet Tracing 1

Color the pictures and trace the letters.

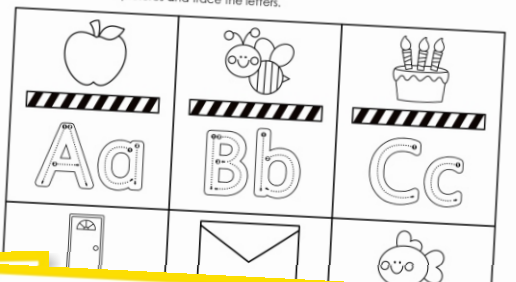

Name: \_\_\_\_\_

## Beginning Sounds 1

Cut and paste the pictures under the matching letter.



Name: \_\_\_\_\_

## Letters in My Name

Color the letters that make up your name.

My name is: \_\_\_\_\_

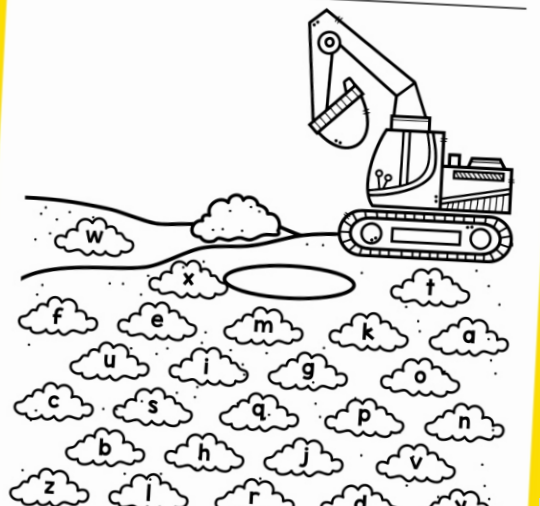

**Thank you** for downloading this product; I hope you will enjoy using it and that it will be a valuable resource for you! I value your feedback, so please don't hesitate to contact me if you have any concerns whatsoever as I will endeavour to address them. And if you like what I've done, please let me know by leaving feedback at my online store :)

Lavinia

[lavinia@kinder-resources.com](mailto:lavinia@kinder-resources.com)

**ILLUSTRATIONS** Kari Bolt, Little Red, Hidesy's Clipart, Dancing Crayon Designs, Whimsy Clips, PartyHead Graphics, Ramona Majdis, Zip-a-Dee-doo-dah-Designs, Bunny on a Cloud, Krista Wallden - Creative Clips, Creating4 the Classroom, Rainbow Sprinkle Studio - Sasha Mitten, First Class Clipart, Erin Colleen Design

[teacherspayteachers.com/Store/Kari-Bolt](https://www.teacherspayteachers.com/Store/Kari-Bolt)    [teacherspayteachers.com/Store/Littered](https://www.teacherspayteachers.com/Store/Littered)    [teacherspayteachers.com/Store/Hidesys-Clipart](https://www.teacherspayteachers.com/Store/Hidesys-Clipart)  
[dancingcrayon.com](https://www.dancingcrayon.com)    [teacherspayteachers.com/Store/Whimsy-Clips](https://www.teacherspayteachers.com/Store/Whimsy-Clips)    [teacherspayteachers.com/Store/Partyhead-Graphics](https://www.teacherspayteachers.com/Store/Partyhead-Graphics)  
[teacherspayteachers.com/Store/Ramona-Majdis](https://www.teacherspayteachers.com/Store/Ramona-Majdis)    [teacherspayteachers.com/Store/Zip-a-dee-doo-dah-Designs](https://www.teacherspayteachers.com/Store/Zip-a-dee-doo-dah-Designs)  
[teacherspayteachers.com/Store/Bunny-On-A-Cloud](https://www.teacherspayteachers.com/Store/Bunny-On-A-Cloud)    [teacherspayteachers.com/Store/Krista-Wallden-Creative-Clips](https://www.teacherspayteachers.com/Store/Krista-Wallden-Creative-Clips)  
[teacherspayteachers.com/Store/Creating4-The-Classroom](https://www.teacherspayteachers.com/Store/Creating4-The-Classroom)    [teacherspayteachers.com/Store/Rainbow-Sprinkle-Studio-Sasha-Mitten](https://www.teacherspayteachers.com/Store/Rainbow-Sprinkle-Studio-Sasha-Mitten)  
[teacherspayteachers.com/Store/First-Class-Clipart](https://www.teacherspayteachers.com/Store/First-Class-Clipart)    [teacherspayteachers.com/Store/Erin-Colleen-Design](https://www.teacherspayteachers.com/Store/Erin-Colleen-Design)

This packet contains Images used under license from Shutterstock.com

**FONTS** [schoolfonts.com.au](https://www.schoolfonts.com.au)    [teacherspayteachers.com/Store/Kimberly-Geswein-Fonts](https://www.teacherspayteachers.com/Store/Kimberly-Geswein-Fonts)  
[teacherspayteachers.com/Store/Ramonam-Graphics](https://www.teacherspayteachers.com/Store/Ramonam-Graphics)

**PRINTING TIP** This resource has been designed for printing on A4-sized paper. If you are printing on a different size, select "shrink to printable area" or "print to fit page" (or a similar option) in order for the contents of this unit to print correctly.

Copyright © 2023 by Lavinia Pop - All rights reserved by author.

Purchase of this item entitles the purchaser the right to reproduce the pages for personal and classroom use. Duplication for other classes, an entire school or commercial purposes is strictly prohibited without written permission from the author. Minor editing is permitted only for personal use, however the document remains under copyright even when edited. Posting this item in whole or in part on the Internet in any form is strictly prohibited and is a violation of the Digital Millennium Copyright Act (DMCA).

Please be fair and don't share! If you are not the original purchaser of this file, please visit my store to purchase a copy. [Kinder-Resources.com](https://www.Kinder-Resources.com)

let's connect!



[Kinder-Resources.com](https://www.Kinder-Resources.com)



[facebook.com/inmyworldlavinipop](https://facebook.com/inmyworldlavinipop)



[instagram.com/inmyworld\\_lavinipop](https://instagram.com/inmyworld_lavinipop)



[pinterest.com/lavinipop](https://pinterest.com/lavinipop)

# Introduction

## **About this book**

This book contains a collection of building and construction themed worksheets for use with children in Preschool, Pre-Kindergarten, Transitional Kindergarten and Kindergarten (Prep/Foundation).

Following is an outline of the activities included in this unit and suggestions for use.

## **Digging Up Letters in My Name**

Children will color the letters that make up their name.

## **Dump Truck Cut and Paste Fun**

Children will cut out the different items and paste them together to make a dump truck.

## **Construction Cone Pasting Fun**

**Materials needed:** orange and white torn tissue paper  
Children will paste torn tissue paper to fill in the pumpkin.

## **Construction Pre-Writing Practice (2 pages)**

Children will trace inside the different paths from left to right.

## **Construction Vehicles Tracing Fun (5 pages)**

Children will trace along the dashed lines and then color the picture.

## **Alphabet Tracing (3 pages)**

Children will trace the upper and lower case letters and color the pictures.

## **Dump Truck and Rocks Letters Matching (5 pages)**

Children will color the rocks that match the letters on the dump truck.

## **Construction Missing Letters (2 pages)**

Children will write the missing letters in the empty boxes.

## **Construction sorting Numbers, Letters and Words (2 pages)**

Children will cut and paste the numbers, letter and words in the correct category.

## **Construction Beginning Sounds (7 pages)**

Children will cut and paste the pictures under the correct beginning sound.

## **Construction Syllables**

Children will color the number that shows how many syllables are in each word.

### **Dump Truck Rhyming Words**

Children will draw a line to match the two words that rhyme.

### **Construction CVC Words**

Children will circle the word that matches the picture.

### **Construction Vehicles Sight Words (10 pages)**

Children will cut and paste the matching sight words in the empty boxes.

### **Building a Road Emergent Reader (color and B&W) with comprehension questions**

Children will read the reader and answer the comprehension questions. Two options of the comprehension page are included: one with picture support and one without.

### **Construction What is Different?**

Children will circle the picture that is different in each row.

### **Construction What Doesn't Belong?**

Children will circle the picture that doesn't belong in each row.

### **Sorting Construction Vehicles and Construction Tools**

Children will cut out the items from the bottom of the page and paste them in the correct category.

### **Building a House Sequencing**

Children will cut out the pictures from the side of the page and paste them in order to show the order of events.

### **Construction Site Read and Color**

Children will color the picture following the instructions at the bottom the page.

### **Construction Workers and Cones Number Tracing (2 pages)**

Children will trace the numbers and color the pictures.

### **Dump Truck Rocks Counting**

Children will count the rocks and color the circle with the correct number.

### **Screw Number Match (2 pages)**

Children will cut out the numbers from the side of the page and paste them in the correct boxes.

### **Construction Number Sense (5 pages)**

Children will cut out the different number representations and paste them in the correct boxes.

### **Dump Truck Missing Numbers**

Children will cut and paste the numbers in the empty boxes.

### **Construction Number Order (2 pages)**

Children will cut out the puzzle strips from the bottom of the page and paste them in order to reveal the picture.

### **Construction Which Group Has More?**

Children will circle the group that has more.

### **Construction Count and Graph**

Children will count how many of each picture and complete the graph.

### **Dump Truck Shapes**

Children will use the code to color the different sections.

### **Tools Height Order**

Children will cut and paste the tools from shortest to tallest.

### **Construction Site Weight Order**

Children will cut and paste the objects from shortest to tallest.

### **Matching Shadows**

Children will cut and paste the pictures on to top of their matching shadows.

### **Matching Shadows**

Children will cut and paste the missing halves to complete each picture.

### **Hammer and Toolbox Prepositions**

Children will color the word that shows the position of the hammer.

### **Construction Site Patterns (AB)**

Children will cut out the pictures from the bottom of the page and paste them in the correct box to complete each pattern.

Happy Teaching :)

Name: \_\_\_\_\_



# Pre-Writing Practice 1

Trace inside each path to help the construction workers get to the site.

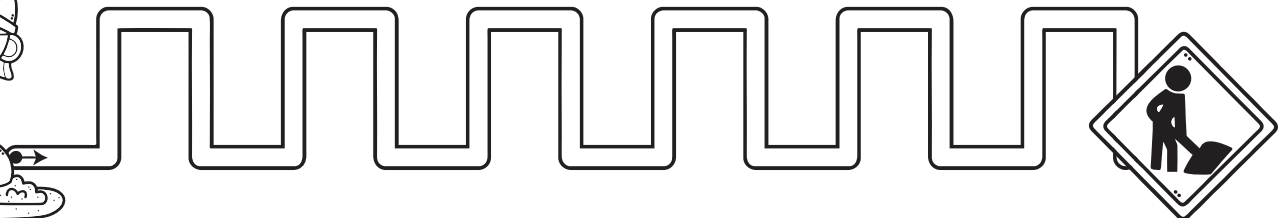
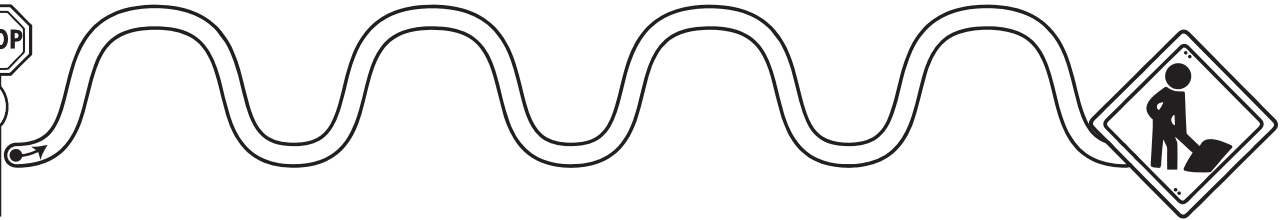
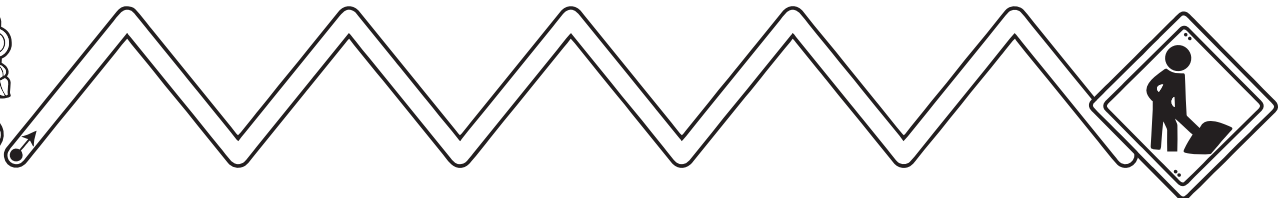
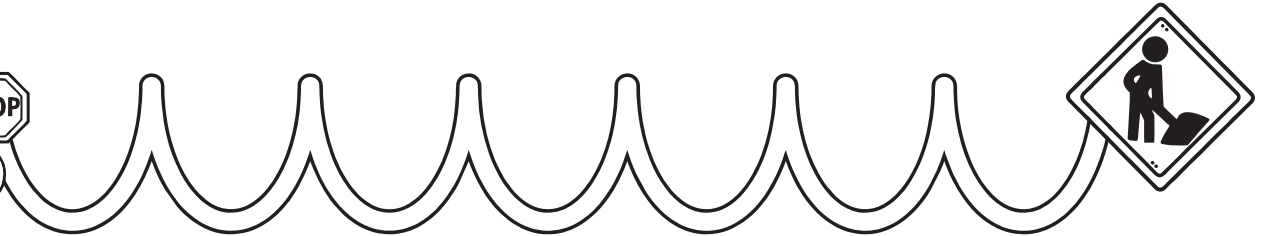
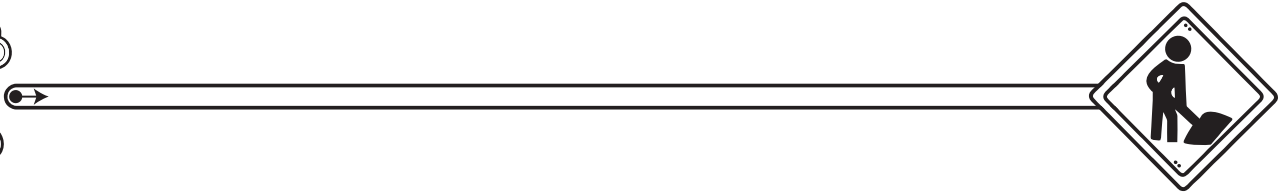



Name:



## Tracing Fun 1

Trace along the dotted lines. Color the picture.

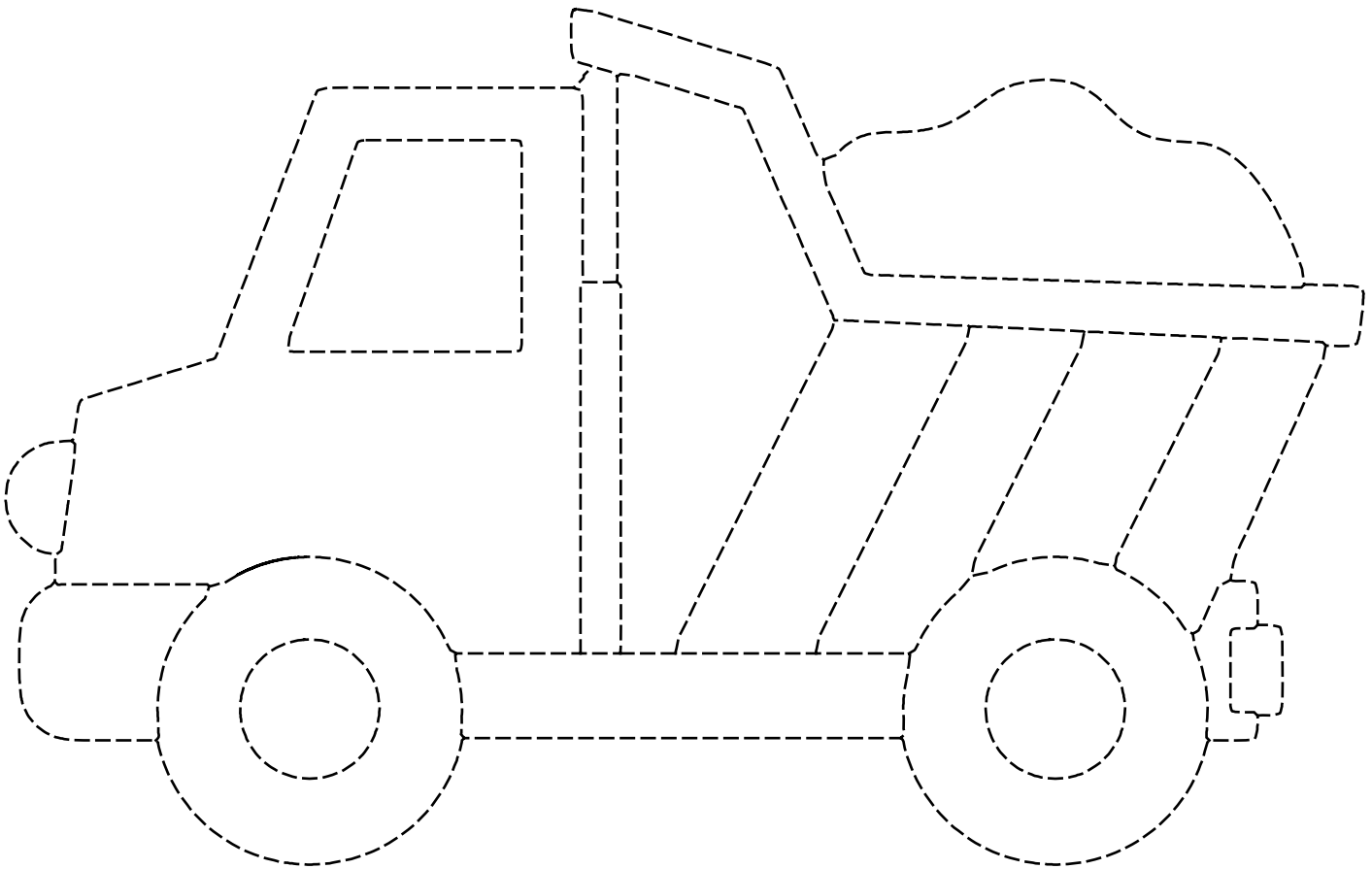

dump  
truck

Name: \_\_\_\_\_



# Alphabet Tracing 1

Color the pictures and trace the letters.

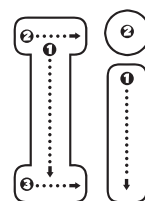
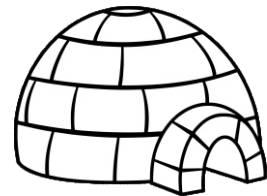
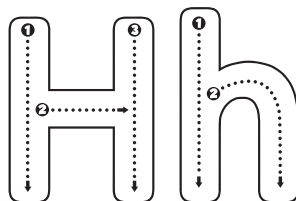
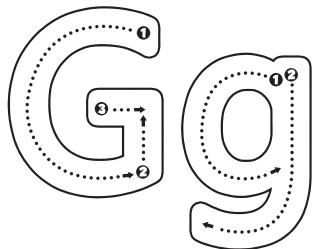
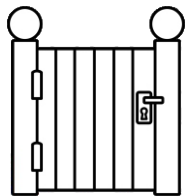
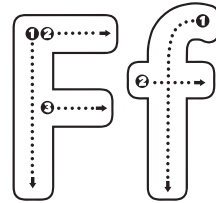
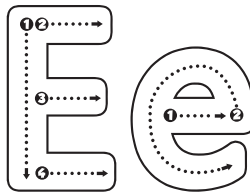
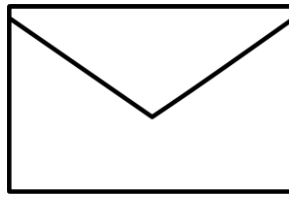
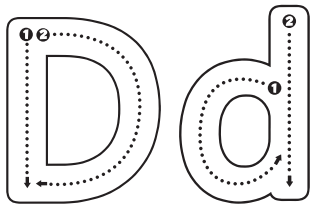
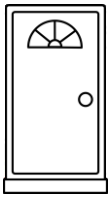
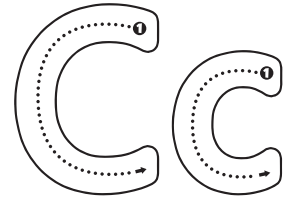
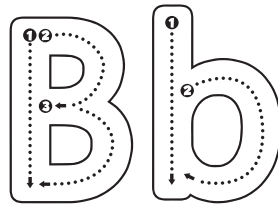
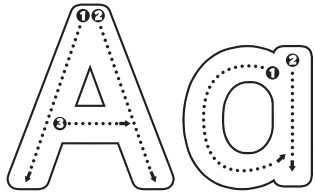
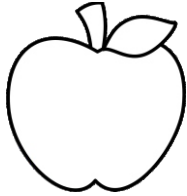



Name: \_\_\_\_\_



# Matching Letters 1

Color all the rocks that match the letters on the dump truck.

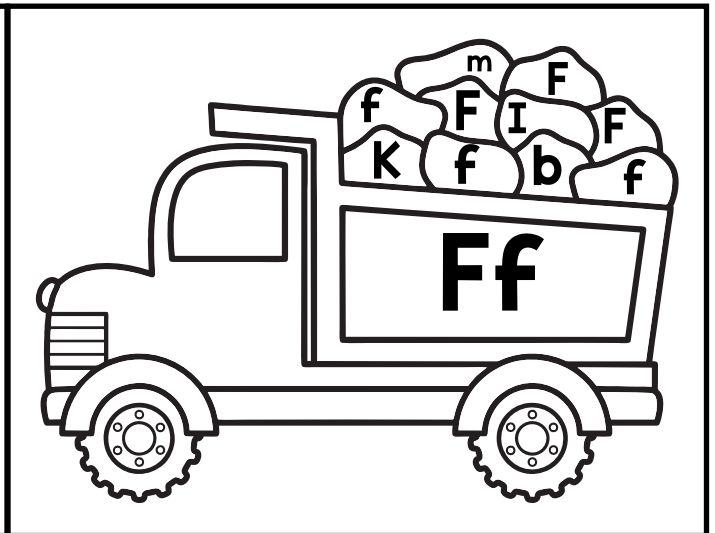
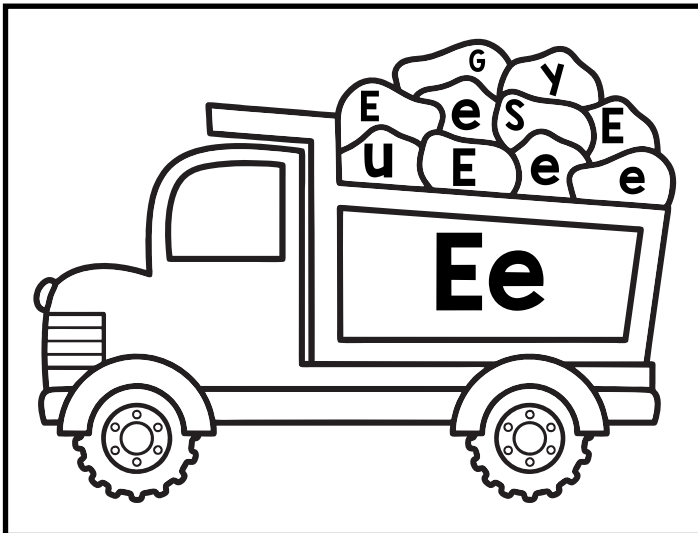
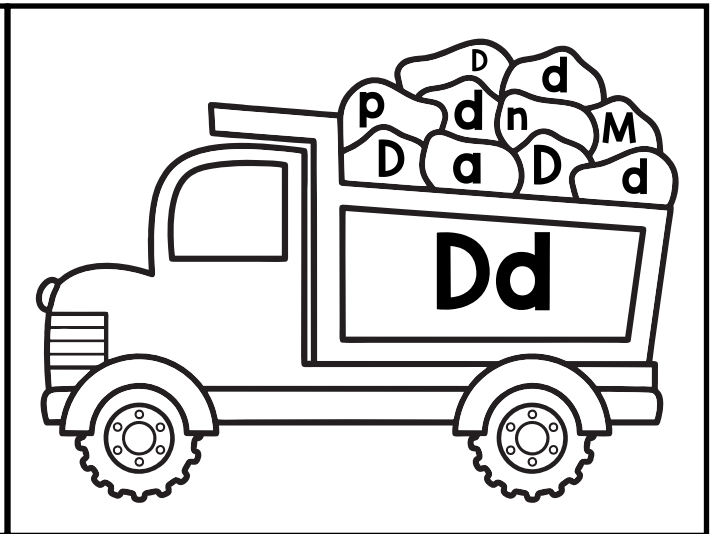
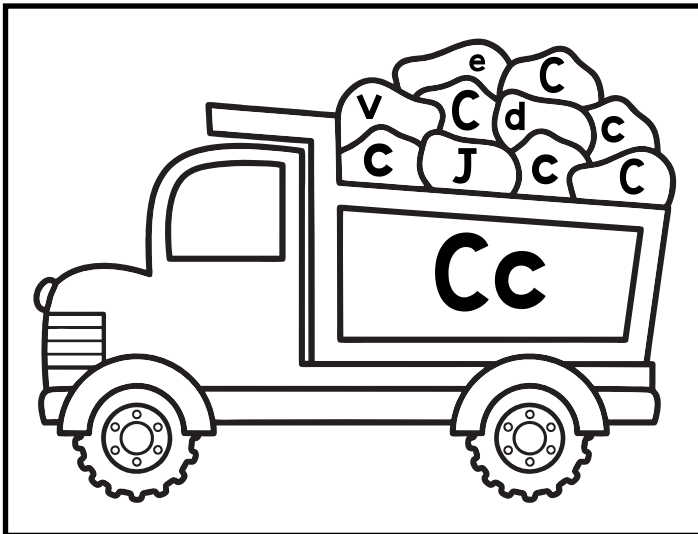
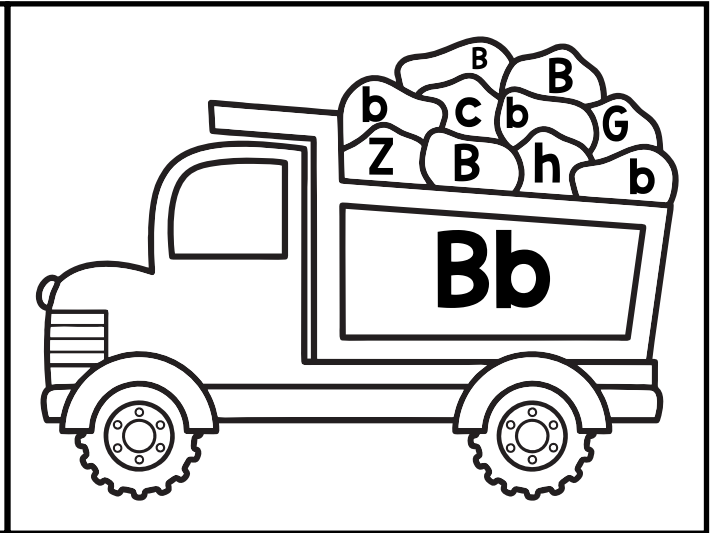
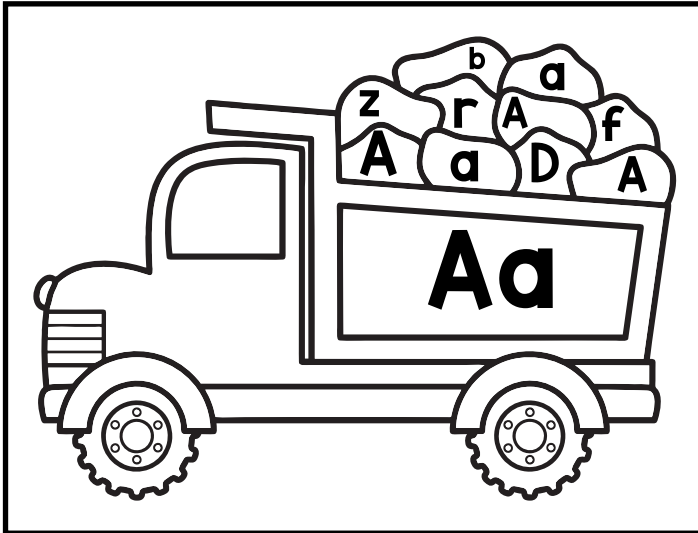

Name: \_\_\_\_\_

\_\_\_\_\_



# Beginning Sounds 1

Cut and paste the pictures under the matching letter.

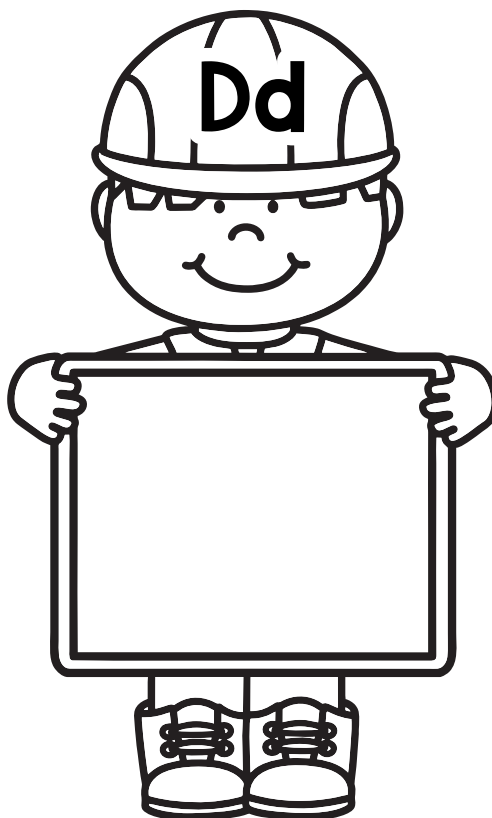
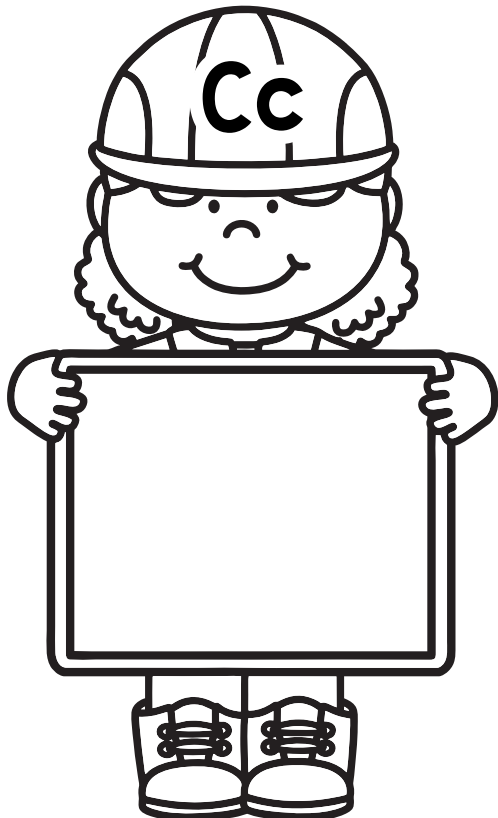
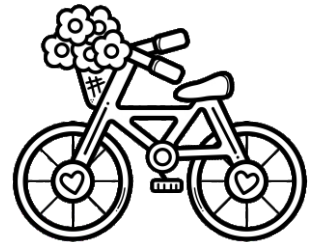
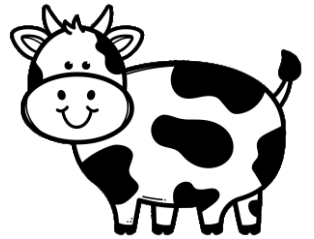
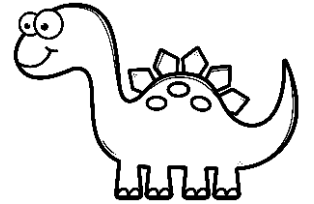
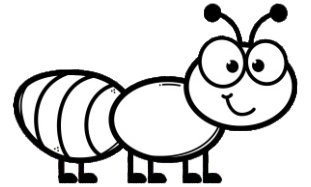
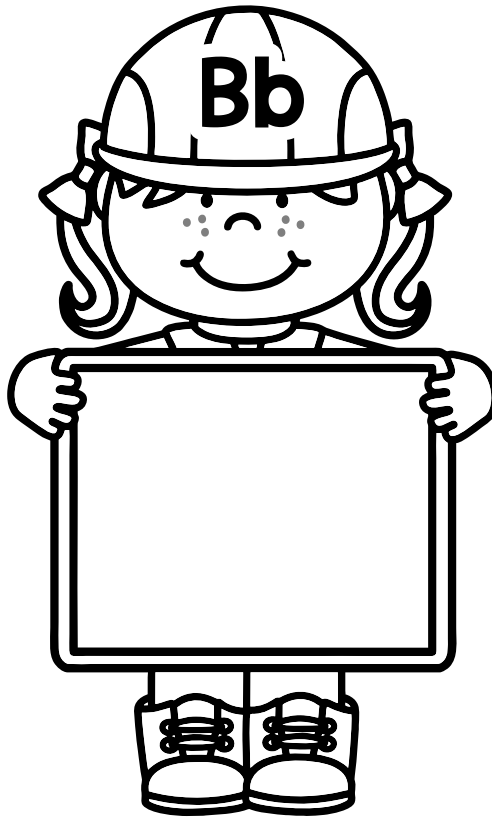
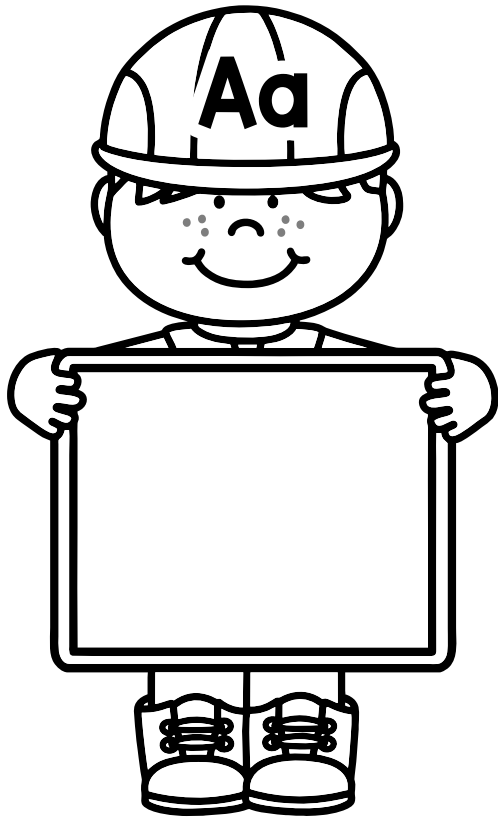
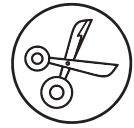

Name: \_\_\_\_\_



# Sight Words 1

Cut and paste the sight words to make a match.

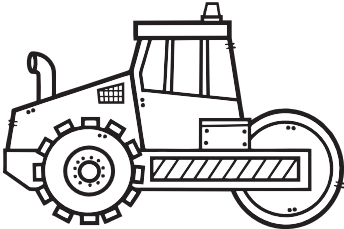

— a —

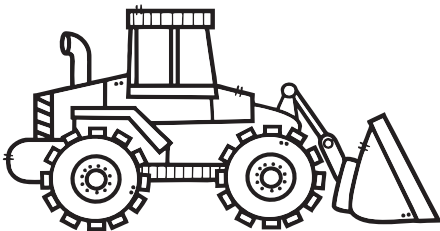

— and —

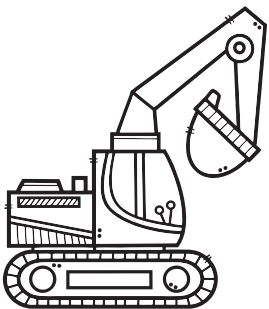

— I —

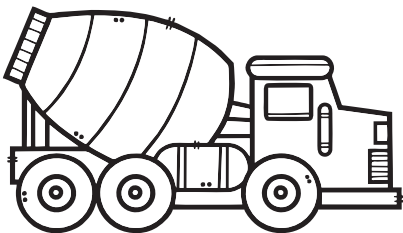

— see —



and	a
see	I

# Building a Road

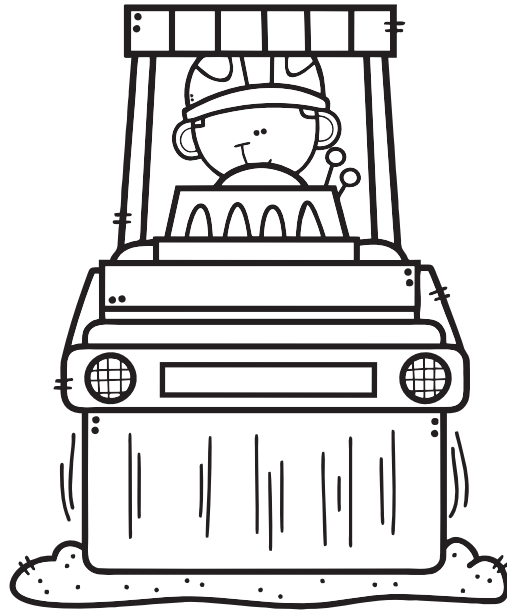

Name \_\_\_\_\_

Lavinia Pop © 2023

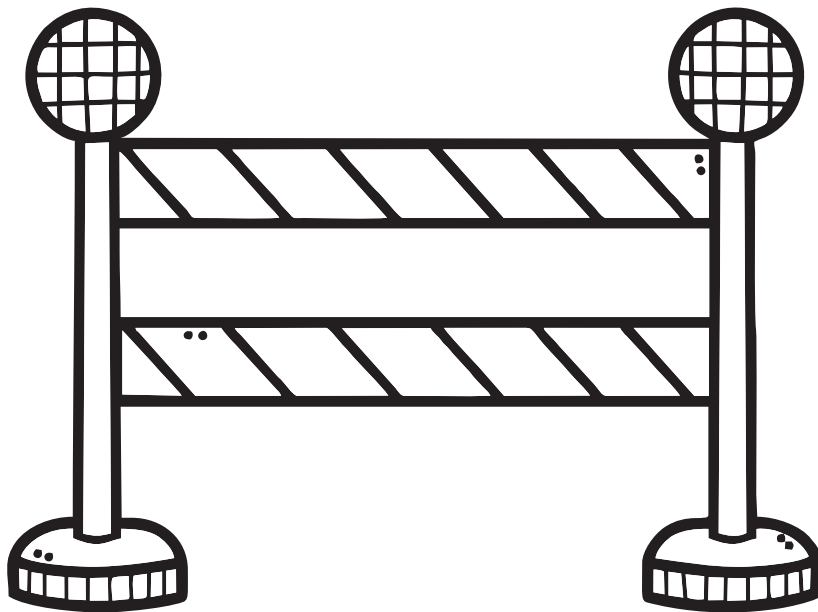

First, I see a barricade.

# Building a Road



Name

Lavinia Pop © 2023

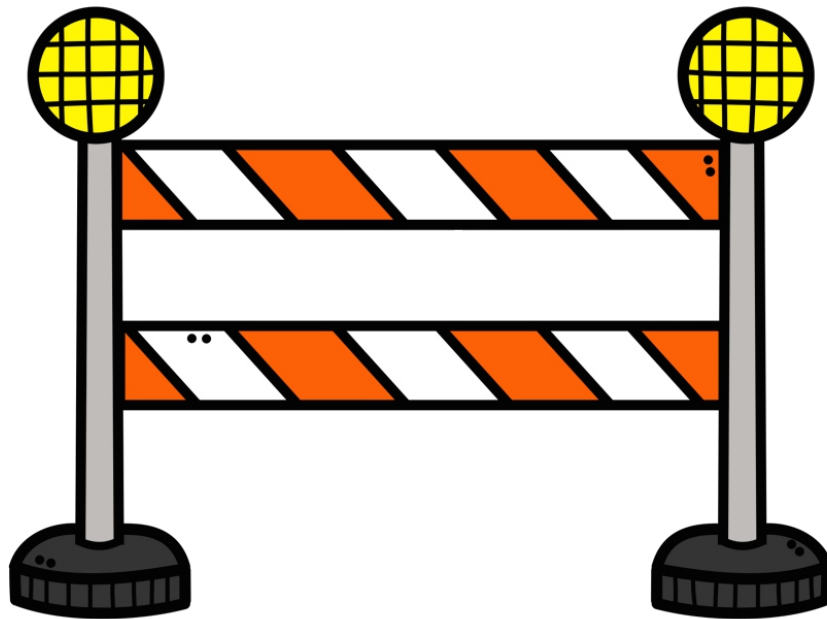

First, I see a barricade.

Name:



## Reading Comprehension

Answer the questions.

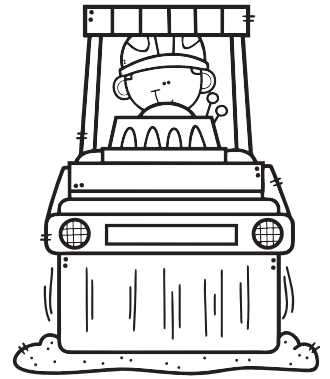

1. What is the book about?

- A** construction vehicles
- B** building a road

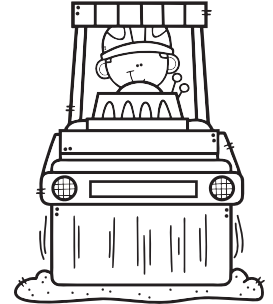

2. What do I see first?

- A** a barricade
- B** workers

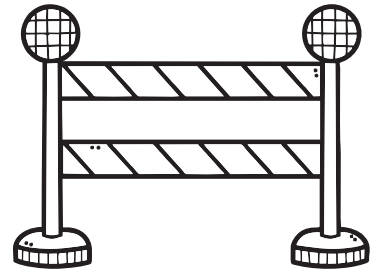

3. What does a road roller do?

- A** digs the ground
- B** runs over the asphalt

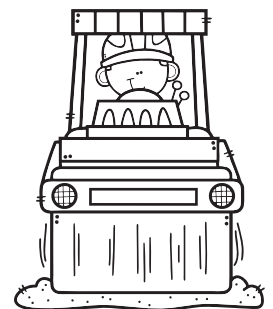

4. What do I see last?

- A** the new road
- B** a road roller

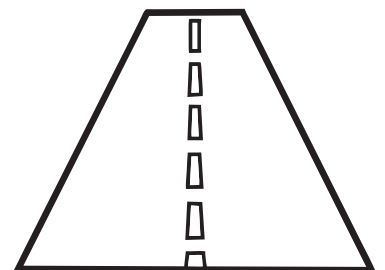



Name: \_\_\_\_\_



# Number Tracing 1

Color the pictures and trace the numbers.

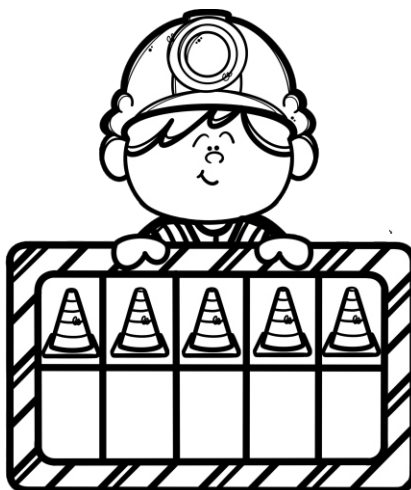
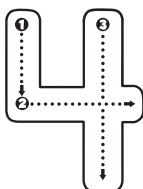
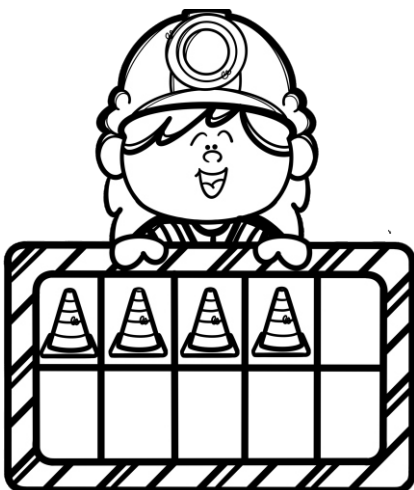
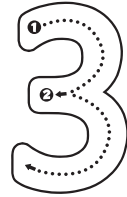
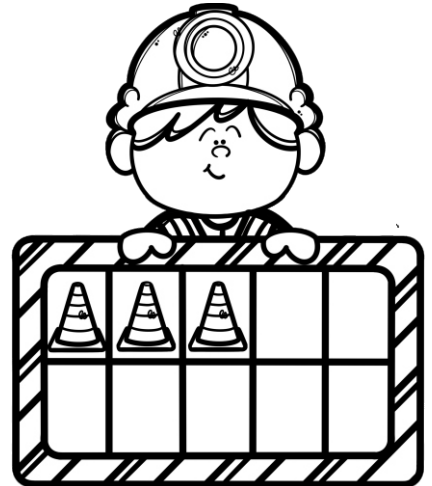
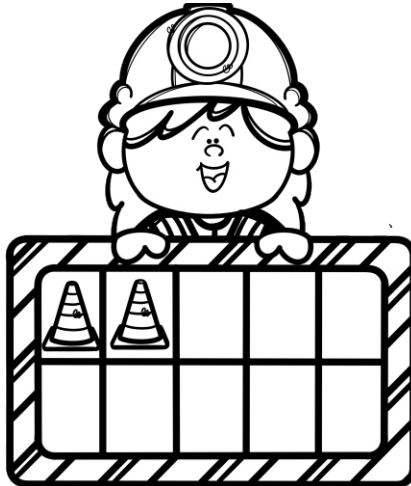
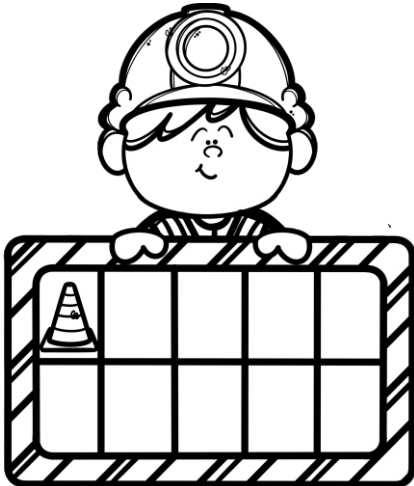

Name: \_\_\_\_\_



## Number Sense 2

Cut and paste the different ways to show the numbers in the correct boxes.



--	--	--

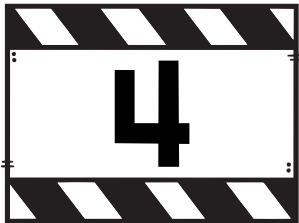

--	--	--





Name:



## Number Order 1-5

Cut and paste the number strips in order.

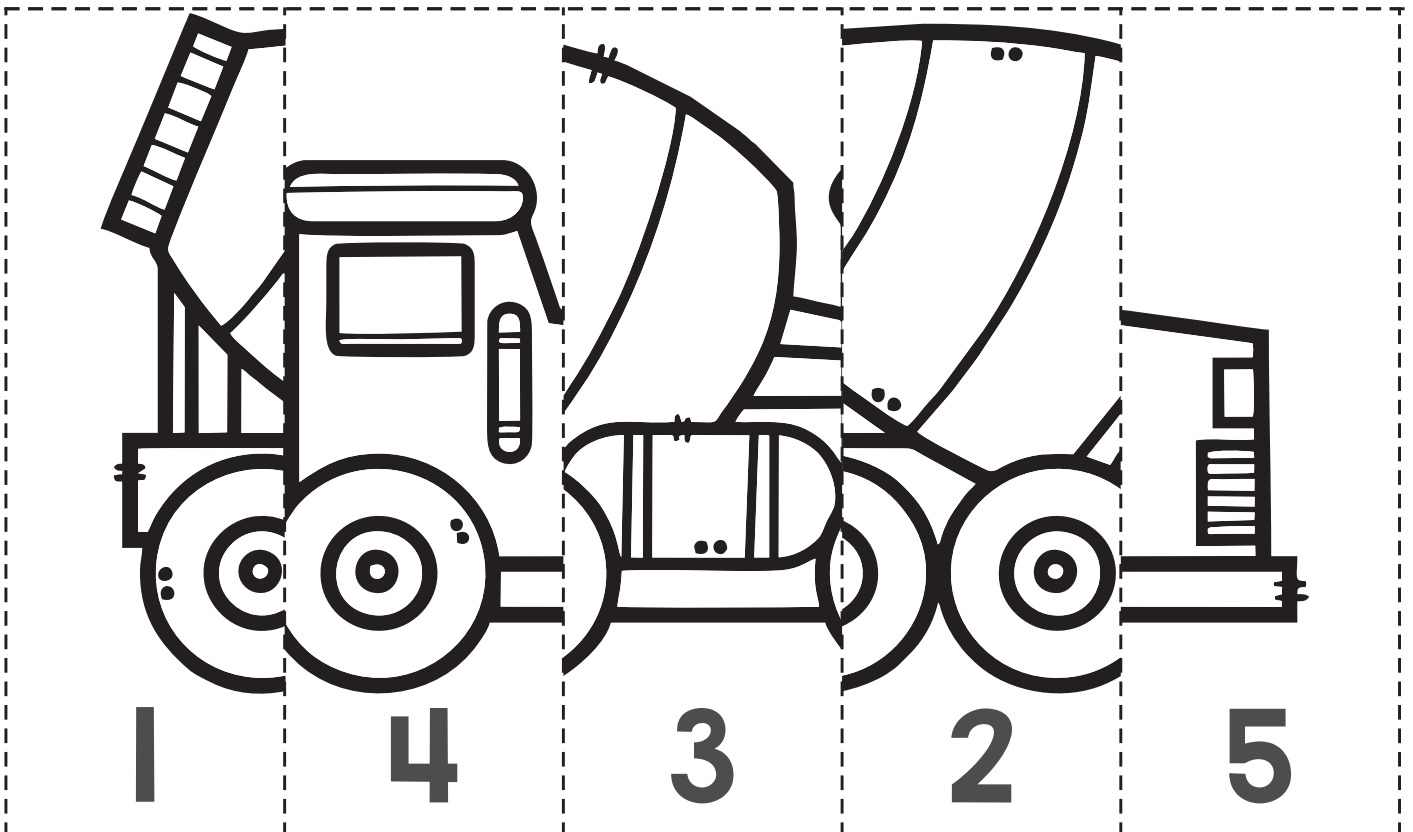
--	--	--	--	--











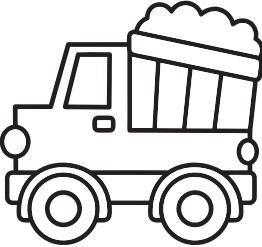

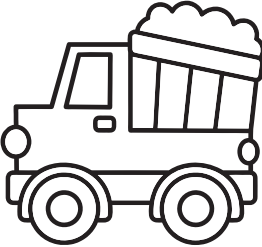

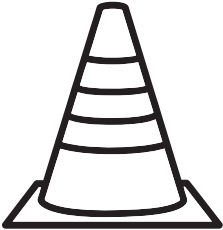

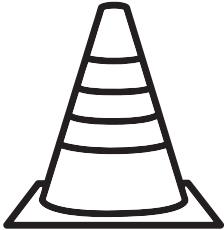
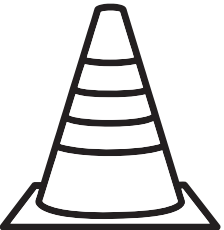
Name: \_\_\_\_\_

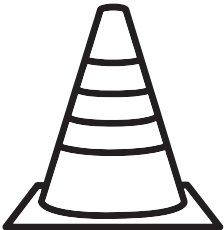



# Patterns AB

Cut and paste the pictures in the empty boxes to complete each pattern.

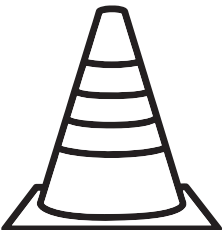

			
---	---	--	---