

# Gingerbread PRESCHOOL

## CENTERS

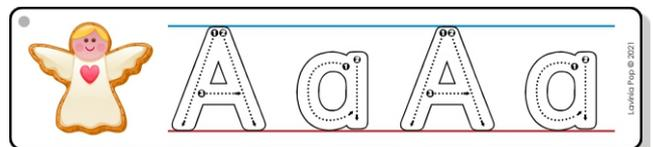
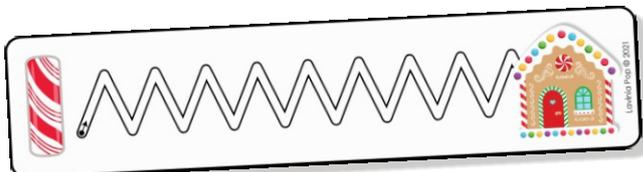
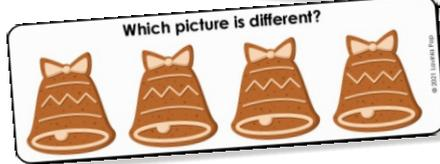
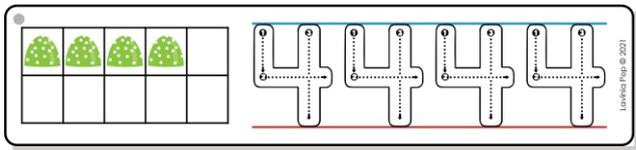

**Thank you** for downloading this product; I hope you will enjoy using it and that it will be a valuable resource for you! I value your feedback, so please don't hesitate to contact me if you have any concerns whatsoever as I will endeavour to address them. And if you like what I've done, please let me know by leaving feedback at my online store :)

Lavinia

[lavinia@inmyworld.com.au](mailto:lavinia@inmyworld.com.au)

**ILLUSTRATIONS** Kari Bolt, Little Red, Dancing Crayon Designs, Whimsy Clips, Hidesy's Clipart, Ramona Majdis, Zip-a-Dee-doo-dah-Designs, Bunny on a Cloud

[www.teacherspayteachers.com/Store/Kari-Bolt](http://www.teacherspayteachers.com/Store/Kari-Bolt)      [www.teacherspayteachers.com/Store/Littlered](http://www.teacherspayteachers.com/Store/Littlered)

[www.dancingcrayon.com](http://www.dancingcrayon.com)      [www.teacherspayteachers.com/Store/Whimsy-Clips](http://www.teacherspayteachers.com/Store/Whimsy-Clips)      [www.teacherspayteachers.com/Store/Hidesys-Clipart](http://www.teacherspayteachers.com/Store/Hidesys-Clipart)

[www.teacherspayteachers.com/Store/Ramona-Majdis](http://www.teacherspayteachers.com/Store/Ramona-Majdis)      [www.teacherspayteachers.com/Store/Zip-a-dee-doo-dah-Designs](http://www.teacherspayteachers.com/Store/Zip-a-dee-doo-dah-Designs)

[www.teacherspayteachers.com/Store/Bunny-On-A-Cloud](http://www.teacherspayteachers.com/Store/Bunny-On-A-Cloud)

This packet contains Images used under license from Shutterstock.com

**FONTS** [www.schoolfonts.com.au](http://www.schoolfonts.com.au)      [www.teacherspayteachers.com/Store/Kimberly-Geswein-Fonts](http://www.teacherspayteachers.com/Store/Kimberly-Geswein-Fonts)  
[www.teacherspayteachers.com/Store/Ramonam-Graphics](http://www.teacherspayteachers.com/Store/Ramonam-Graphics)

**PRINTING TIP** This resource has been designed for printing on A4-sized paper. If you are printing on a different size, select "shrink to printable area" or "print to fit page" (or a similar option) in order for the contents of this unit to print correctly.

Copyright © 2021 by Lavinia Pop - All rights reserved by author.

Purchase of this item entitles the purchaser the right to reproduce the pages for personal and classroom use. Duplication for other classes, an entire school or commercial purposes is strictly prohibited without written permission from the author. Minor editing is permitted only for personal use, however the document remains under copyright even when edited. Posting this item in whole or in part on the Internet in any form is strictly prohibited and is a violation of the Digital Millennium Copyright Act (DMCA).

Please be fair and don't share! If you are not the original purchaser of this file, please visit my blog to obtain a link to one of my online stores. [www.inmyworld.com.au](http://www.inmyworld.com.au)

let's connect!



[www.inmyworld.com.au](http://www.inmyworld.com.au)



[www.facebook.com/inmyworldlavinia](http://www.facebook.com/inmyworldlavinia)



[www.instagram.com/inmyworld\\_lavinia](http://www.instagram.com/inmyworld_lavinia)



[www.pinterest.com/lavinia](http://www.pinterest.com/lavinia)

# INTRODUCTION

## **About this book**

This book contains 21 printable activities for use with children in Preschool, Pre-Kindergarten, Transitional Kindergarten and Kindergarten (Prep/Foundation).

To prepare the contents of this packet for use, laminate each printed page for durability and re-use and then cut along the dotted lines.

I have included photos showing how the activities in this packet can be used. You may print them and store them with the matching activity as a visual instruction card.

Following is an outline of the activities included in this unit and suggestions for preparation and use.

## **Gingerbread play dough mats (5 mats)**

**Materials needed:** play dough in various colours

Children will use the play dough to decorate a gingerbread cookie.

## **Gingerbread house pre-writing practice**

**Materials needed:** erasable markers

Children will trace the pre-writing lines and curves.

## **Gingerbread upper and lower case letter tracing**

**Materials needed:** erasable markers

Children will trace the upper and lower case letters.

## **Gingerbread upper-lower case letter matching**

Children will match the lower case cards with the upper case letters on the trays.

## **Gingerbread house beginning sounds matching**

Children will match the pictures to the correct gingerbread house.

## **Gingerbread syllables**

**Materials needed:** clothes pegs/pins

Children will identify the number of syllables in each word and show their answer by clipping a peg on the corresponding number.

## **Gingerbread house rhyming words matching**

Children will match the rhyming pictures from the roof to the base of the gingerbread house.

### **Gingerbread man CVC word building**

Children will use the candy letters to build the words on each gingerbread man.

### **Gingerbread man and house sight word matching**

Children will match the gingerbread man to the house with the same word.

### **Gingerbread cookie shadow matching**

Children will match the pictures to their shadows.

### **Which picture is different? cards**

Children will identify the picture that is different.

### **What Doesn't Belong? cards**

Children will identify the picture that doesn't belong.

### **Gingerbread cookie sorting (with and without icing)**

Children will sort the different cookies to the correct pan.

### **Making and decorating cookies 4-part sequencing cards**

Children will order the cards correctly to show the process of making and decorating cookies.

### **Gingerbread boy colour matching**

**Materials needed:** coloured pom-poms or buttons

Children will match the coloured pop-poms to the clown with the matching nose.

### **Gingerbread cookie patterns (AB)**

Children will identify the pattern on the cards and place the correct picture in the empty box to complete the pattern.

### **Number tracing**

**Materials needed:** erasable markers

Children will trace the numbers.

### **Gingerbread cookie number sense (1-10)**

Children will sort the different number representation balls to the correct pan.

### **Gingerbread cookie counting**

Children will count and place the amount out of gingerbread cookies shown on the pan.

### **Gingerbread cookie sorting by size (small, medium, large)**

Children will sort the different gingerbread cookies to the correct pan.

## **Cookie shape sorting**

Children will sort the differently shaped cookies to the correct pan.

Happy Teaching :)



In My World



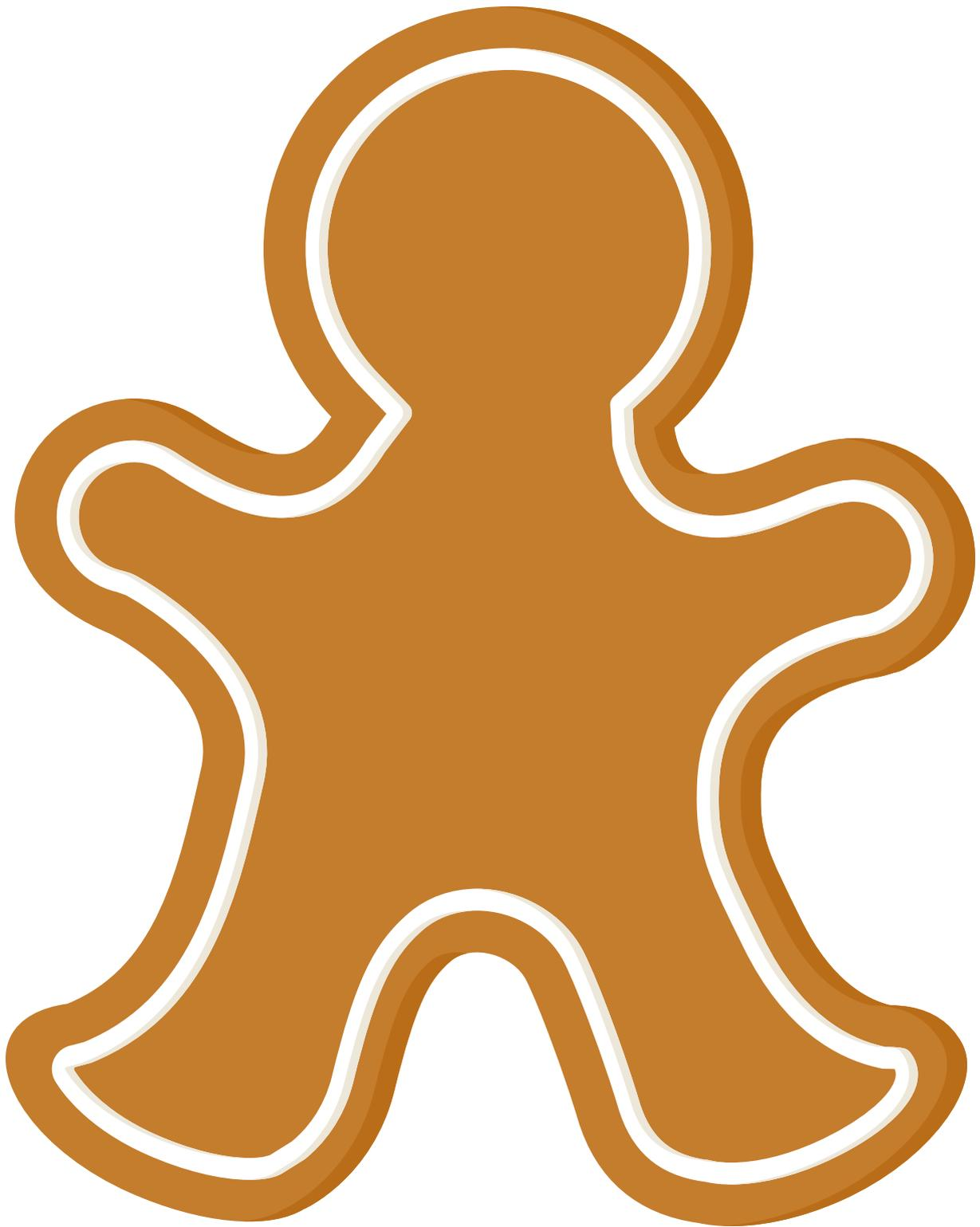



Lavinia Pop © 2021

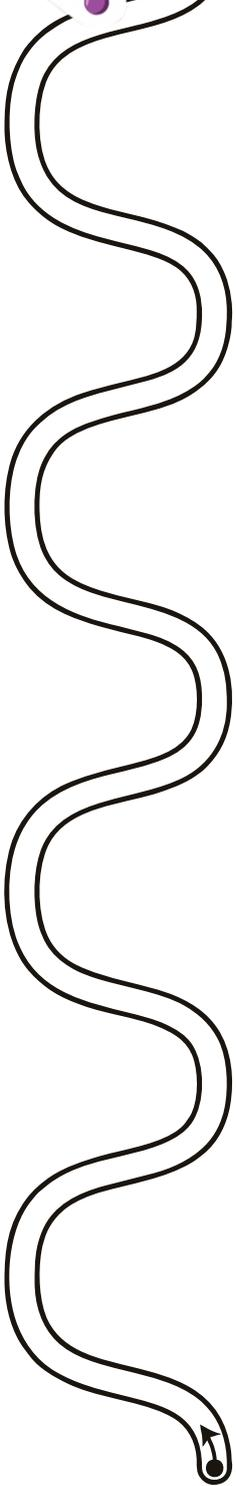

Lavinia Pop © 2021

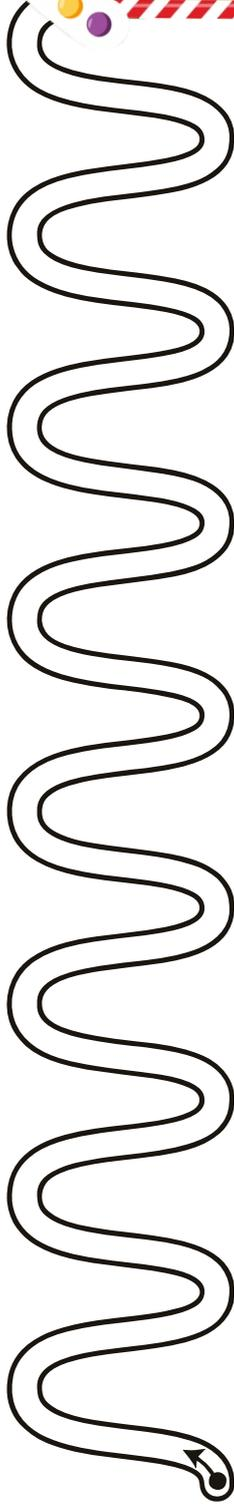

Lavinia Pop © 2021





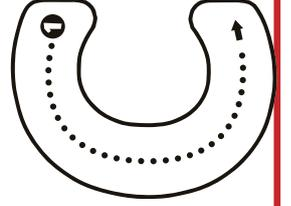
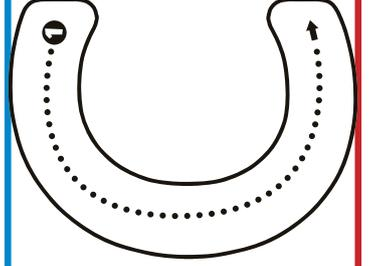
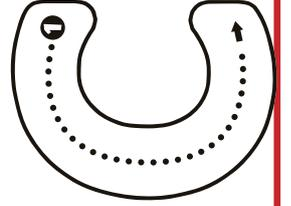
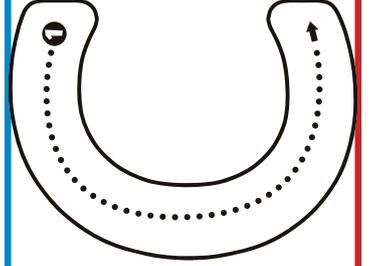
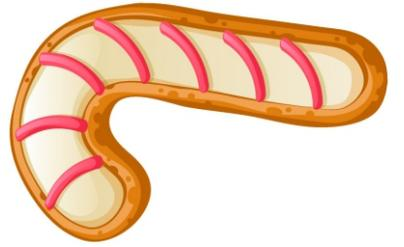
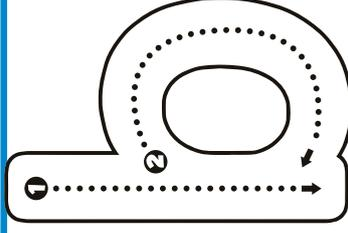
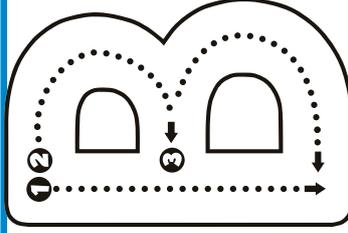
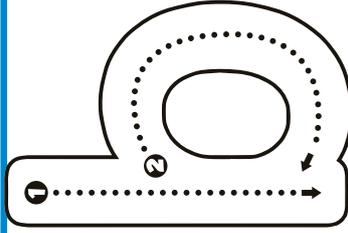
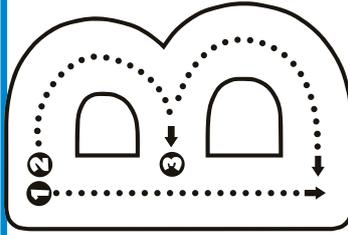
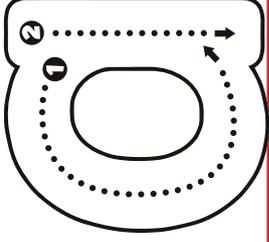
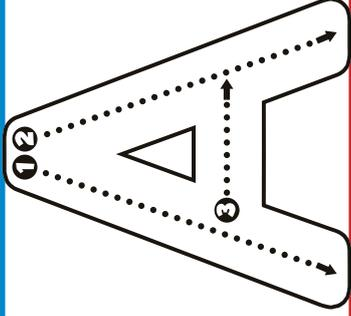
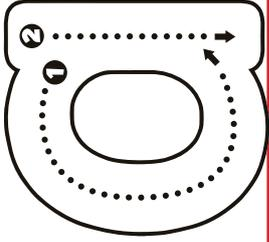
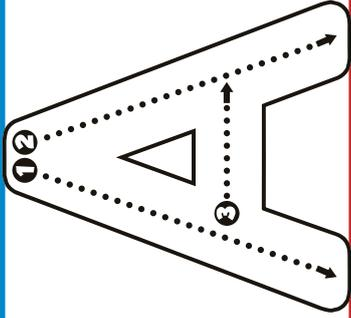



Lavinia Pop © 2021

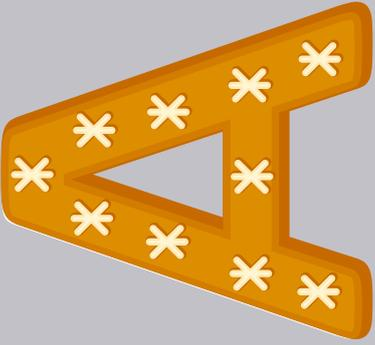

Lavinia Pop © 2021

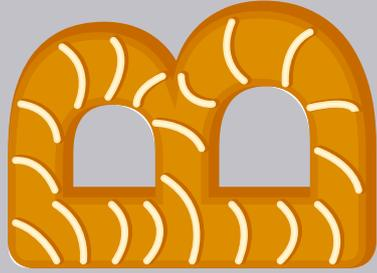

Lavinia Pop © 2021

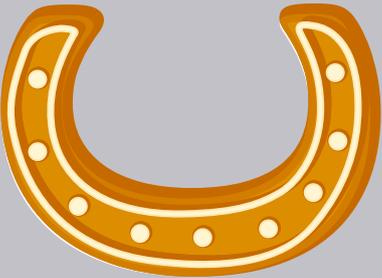

Lavinia Pop © 2021

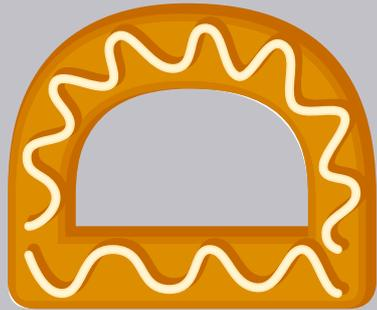











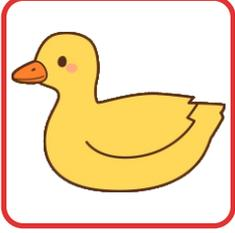



butter

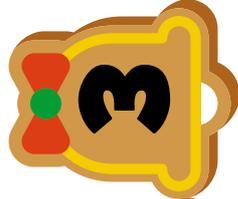
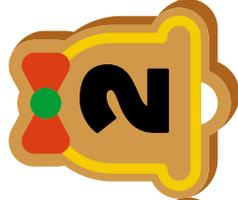
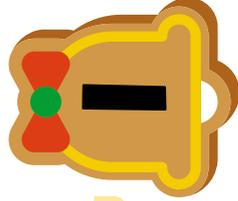

© 2021 Lavinia Pop

sugar

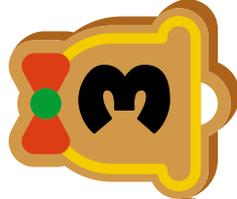
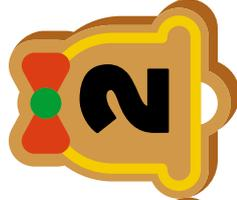
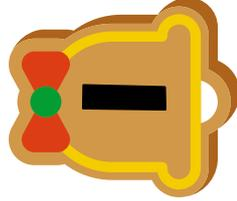

© 2021 Lavinia Pop

egg

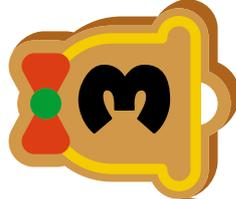
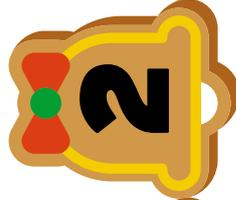
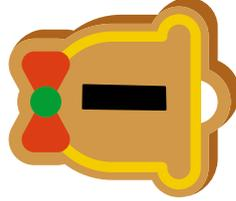
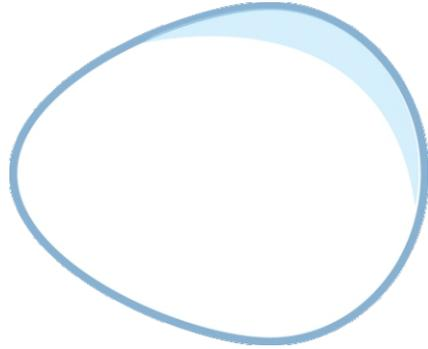

© 2021 Lavinia Pop



In My World





© 2021 Lavinia Pop

© 2021 Lavinia Pop

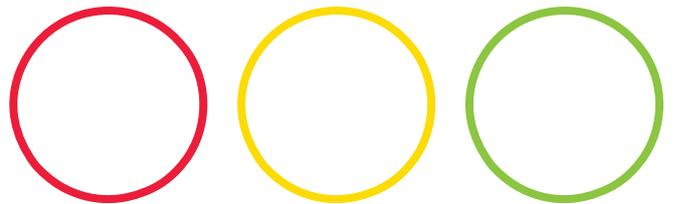
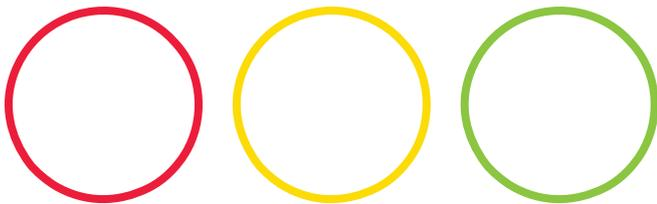

© 2021 Lavinia Pop

© 2021 Lavinia Pop

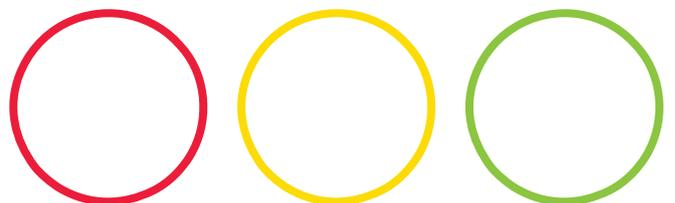
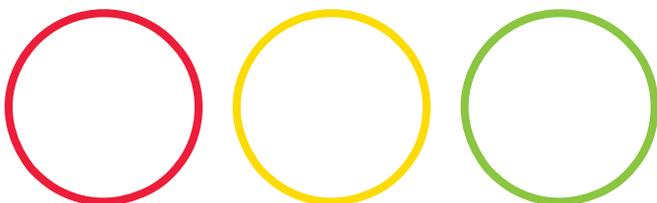



Lavinia Pop © 2021



Lavinia Pop © 2021



Lavinia Pop © 2021



Lavinia Pop © 2021



Lavinia Pop © 2021



Lavinia Pop © 2021



Lavinia Pop © 2021



Lavinia Pop © 2021



Lavinia Pop © 2021



Lavinia Pop © 2021



Lavinia Pop © 2021



Lavinia Pop © 2021





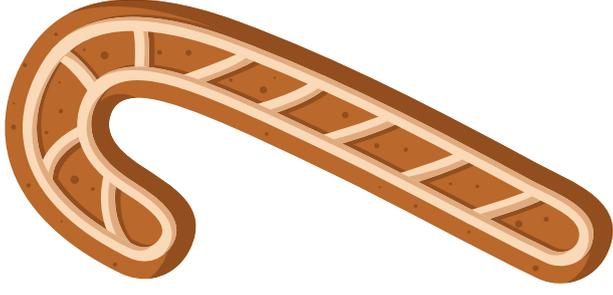

© 2021 Lavinia Pop

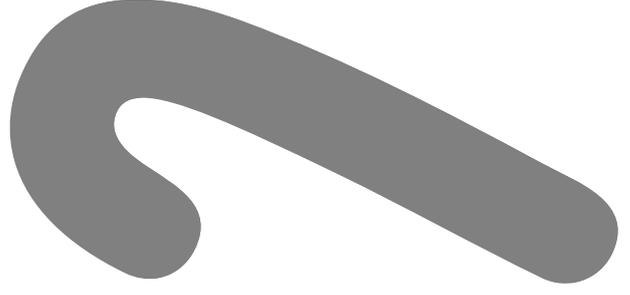

© 2021 Lavinia Pop



© 2021 Lavinia Pop



© 2021 Lavinia Pop

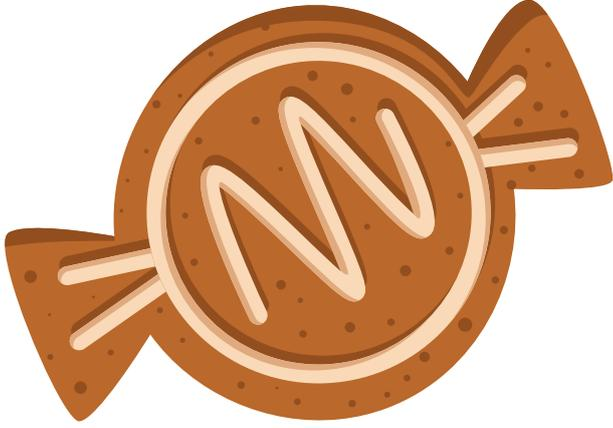

© 2021 Lavinia Pop

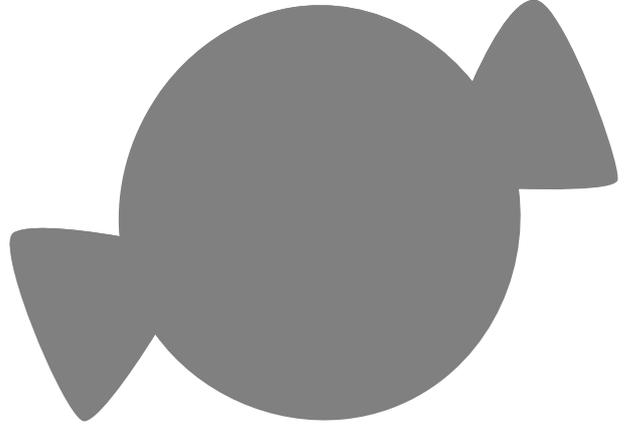

© 2021 Lavinia Pop

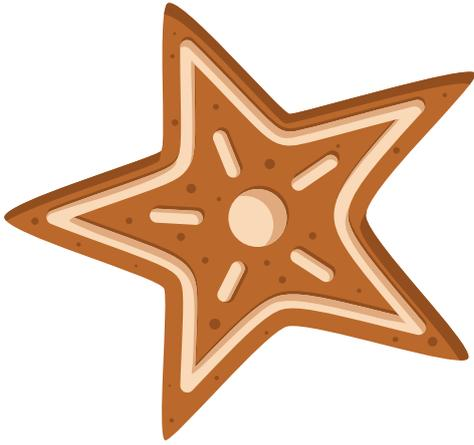

© 2021 Lavinia Pop

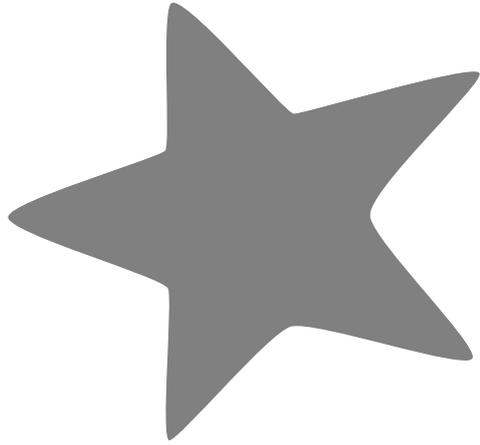

© 2021 Lavinia Pop

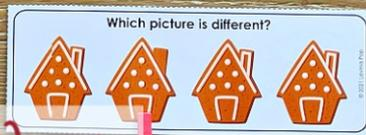
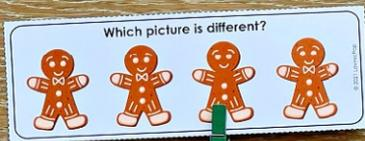
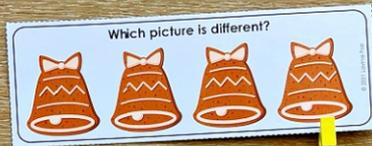
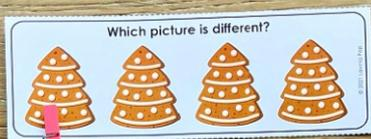

In My World





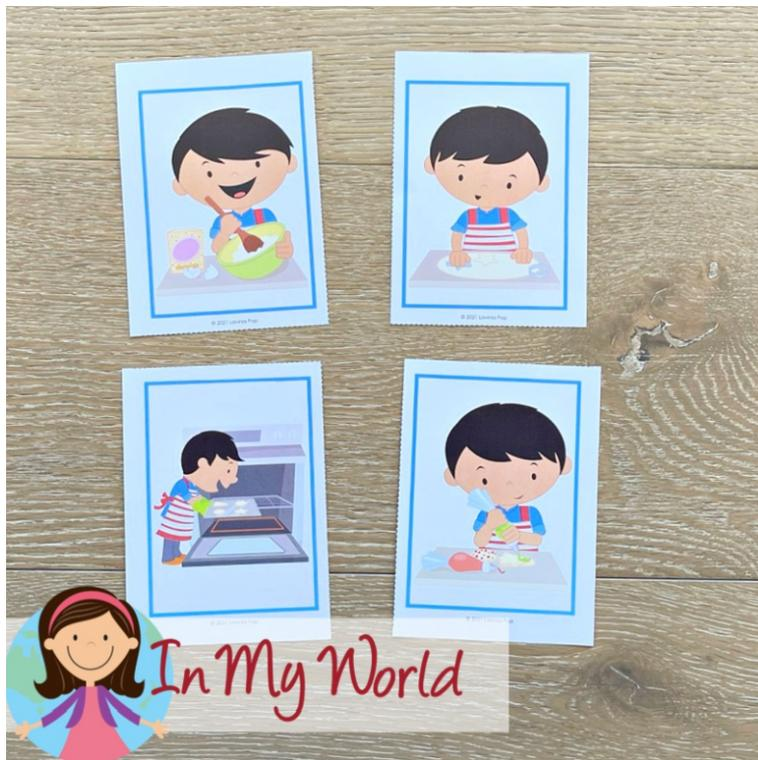







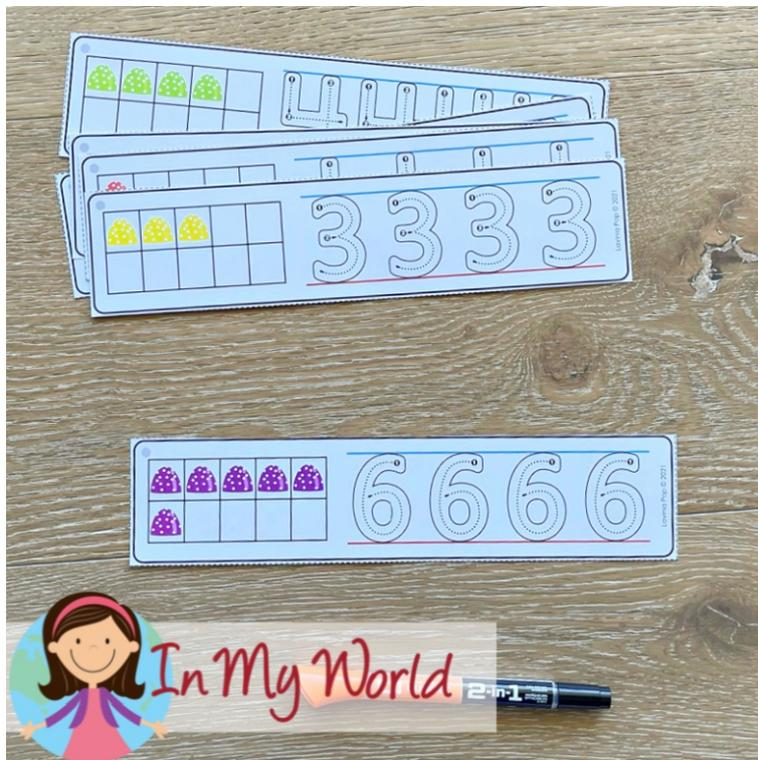

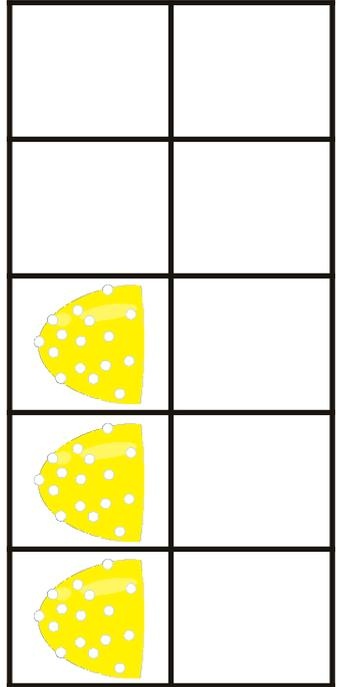
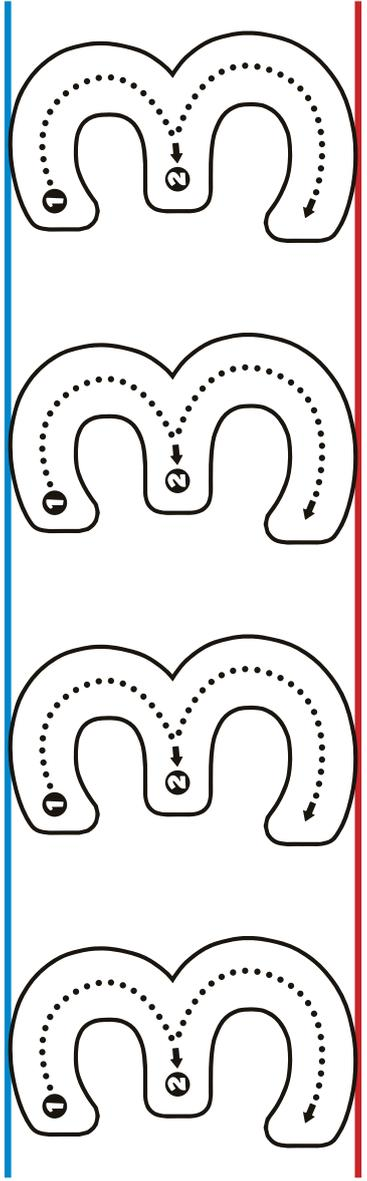
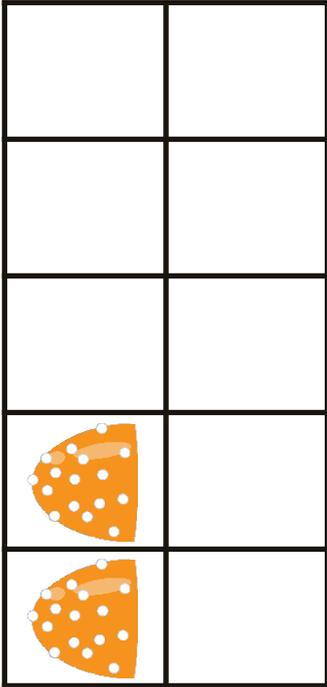
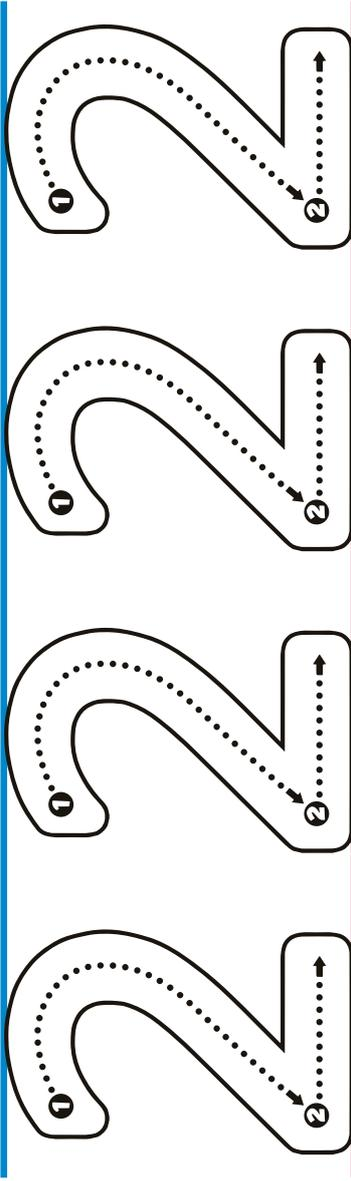
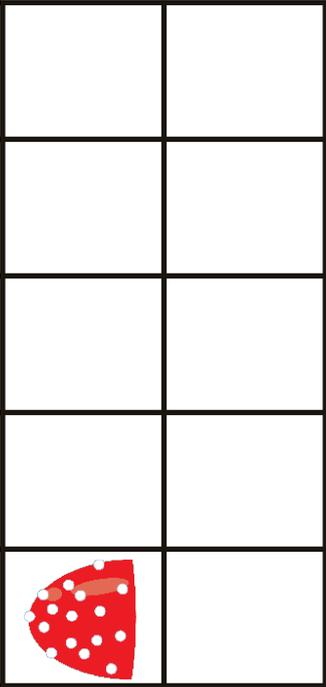
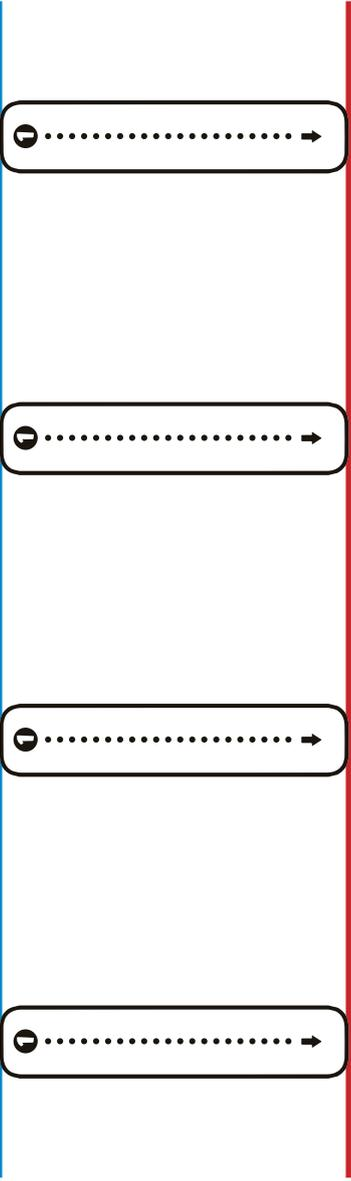



1

2

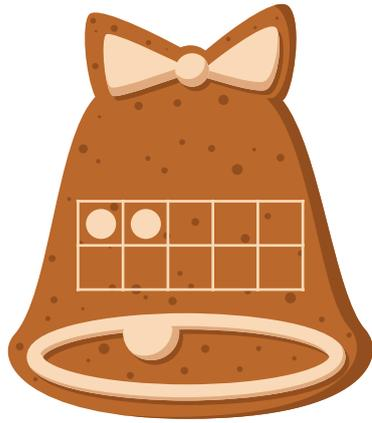
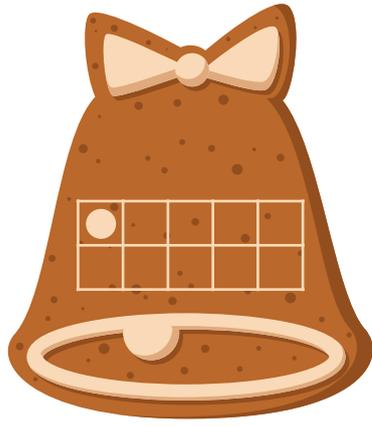



In My World



**small**

**medium**

**large**



© 2021 Lavinia Pop



© 2021 Lavinia Pop



© 2021 Lavinia Pop

