

alphabet



TRACING CARDS

upper and lower case letters with correct letter formation

Lavinia Pop © 2013

Lavinia Pop © 2013

Lavinia Pop © 2013

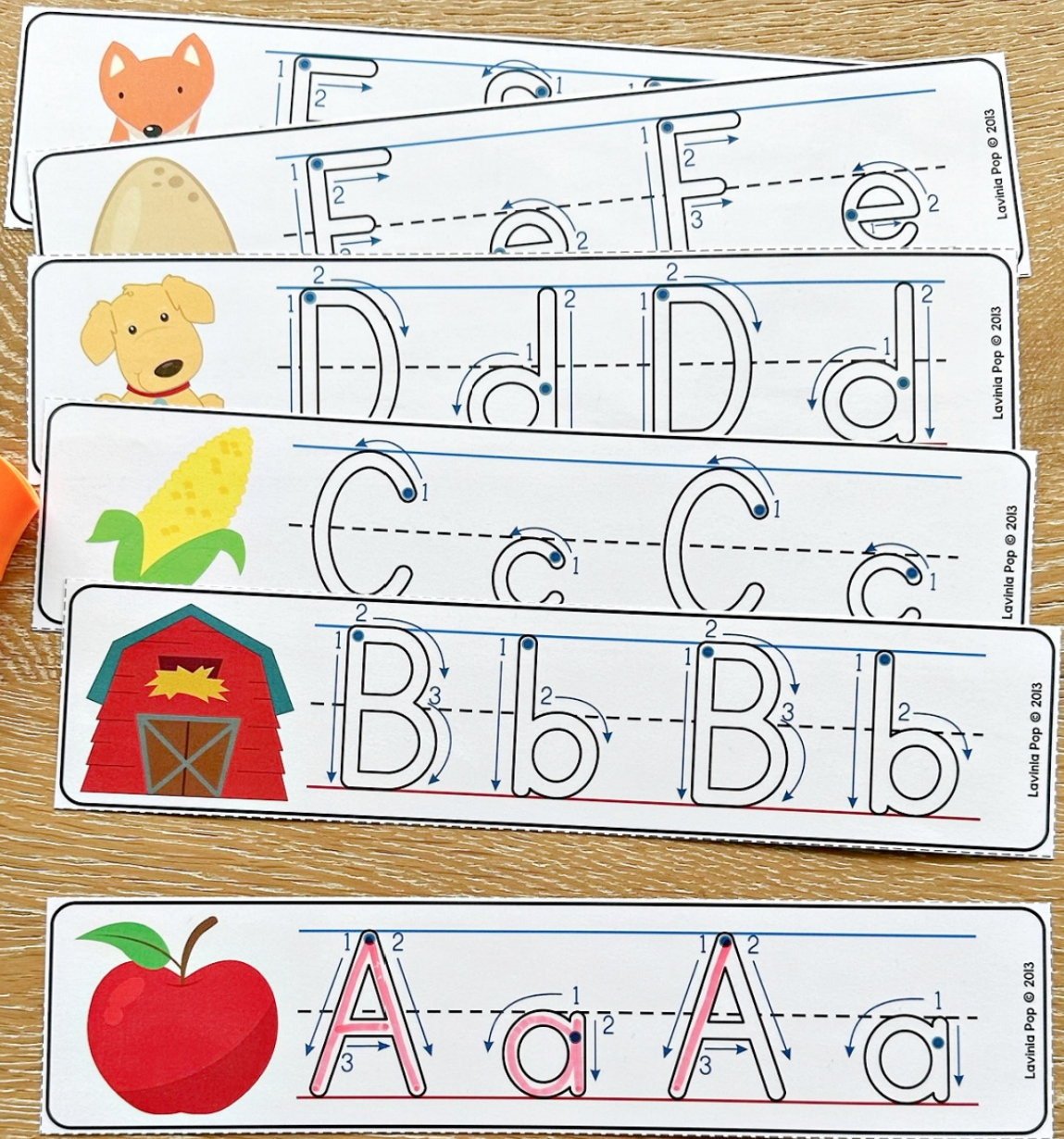

Thank you for downloading this product; I hope you will enjoy using it and that it will be a valuable resource for you! I value your feedback, so please don't hesitate to contact me if you have any concerns whatsoever as I will endeavour to address them. And if you like what I've done, please let me know by leaving feedback at my online store :)

Lavinia

lavinia@kinder-resources.com

ILLUSTRATIONS Kari Bolt, Little Red, Hidesy's Clipart, Dancing Crayon Designs, Whimsy Clips, PartyHead Graphics, Ramona Majdis, Zip-a-Dee-doo-dah-Designs, Bunny on a Cloud, Krista Wallden - Creative Clips, Creating4 the Classroom, Rainbow Sprinkle Studio - Sasha Mitten, First Class Clipart, Erin Colleen Design

[teacherspayteachers.com/Store/Kari-Bolt](https://www.teacherspayteachers.com/Store/Kari-Bolt) [teacherspayteachers.com/Store/Littered](https://www.teacherspayteachers.com/Store/Littered) [teacherspayteachers.com/Store/Hidesys-Clipart](https://www.teacherspayteachers.com/Store/Hidesys-Clipart)
[dancingcrayon.com](https://www.dancingcrayon.com) [teacherspayteachers.com/Store/Whimsy-Clips](https://www.teacherspayteachers.com/Store/Whimsy-Clips) [teacherspayteachers.com/StorePartyhead-Graphics](https://www.teacherspayteachers.com/Store/Partyhead-Graphics)
[teacherspayteachers.com/Store/Ramona-Majdis](https://www.teacherspayteachers.com/Store/Ramona-Majdis) [teacherspayteachers.com/Store/Zip-a-dee-doo-dah-Designs](https://www.teacherspayteachers.com/Store/Zip-a-dee-doo-dah-Designs)
[teacherspayteachers.com/Store/Bunny-On-A-Cloud](https://www.teacherspayteachers.com/Store/Bunny-On-A-Cloud) [teacherspayteachers.com/Store/Krista-Wallden-Creative-Clips](https://www.teacherspayteachers.com/Store/Krista-Wallden-Creative-Clips)
[teacherspayteachers.com/Store/Creating4-The-Classroom](https://www.teacherspayteachers.com/Store/Creating4-The-Classroom) [teacherspayteachers.com/Store/Rainbow-Sprinkle-Studio-Sasha-Mitten](https://www.teacherspayteachers.com/Store/Rainbow-Sprinkle-Studio-Sasha-Mitten)
[teacherspayteachers.com/Store/First-Class-Clipart](https://www.teacherspayteachers.com/Store/First-Class-Clipart) [teacherspayteachers.com/Store/Erin-Colleen-Design](https://www.teacherspayteachers.com/Store/Erin-Colleen-Design)

This packet contains Images used under license from Shutterstock.com

FONTS [schoolfonts.com.au](https://www.schoolfonts.com.au) [teacherspayteachers.com/Store/Kimberly-Geswein-Fonts](https://www.teacherspayteachers.com/Store/Kimberly-Geswein-Fonts)
[teacherspayteachers.com/Store/Ramonam-Graphics](https://www.teacherspayteachers.com/Store/Ramonam-Graphics)

PRINTING TIP This resource has been designed for printing on A4-sized paper. If you are printing on a different size, select "shrink to printable area" or "print to fit page" (or a similar option) in order for the contents of this unit to print correctly.

Copyright © 2013 by Lavinia Pop - All rights reserved by author.

Purchase of this item entitles the purchaser the right to reproduce the pages for personal and classroom use. Duplication for other classes, an entire school or commercial purposes is strictly prohibited without written permission from the author. Minor editing is permitted only for personal use, however the document remains under copyright even when edited. Posting this item in whole or in part on the Internet in any form is strictly prohibited and is a violation of the Digital Millennium Copyright Act (DMCA).

Please be fair and don't share! If you are not the original purchaser of this file, please visit my store to purchase a copy. [Kinder-Resources.com](https://www.Kinder-Resources.com)

let's connect!



[Kinder-Resources.com](https://www.Kinder-Resources.com)



facebook.com/KinderResources



instagram.com/laviniapop_kinder_resources



pinterest.com/laviniapop

INTRODUCTION

Boost letter recognition and handwriting skills with the *Autumn / Fall Write & Wipe Alphabet cards*! These reusable, autumn-themed cards are perfect for helping young learners practice letter formation while exploring fun seasonal words.

Features

- **26 alphabet cards:** Each card features both uppercase and lowercase letters, ensuring comprehensive letter practice and recognition.
- **Autumn-themed beginning sounds:** Each letter card features an autumn-themed word to reinforce beginning sounds. (apple, barn corn, dog, egg, fox garlic, haystack, ill, jar, kite, leaf, mushroom, newspaper, olives, pumpkin, quilt, rake, sunflower, turkey, umbrella, vase, wagon, x-ray, yarn, zipper.)
- **Directional arrows:** Each letter includes directional arrows to guide children on how to correctly form the letters, making learning easier and more effective.
- **Multiple formation options:** Different formation options are provided for the letters G, J, q, and y, accommodating various handwriting styles and preferences.
- **Write & wipe functionality:** The cards are designed for use with a dry-erase marker, allowing for repeated practice and easy clean-up.
- **Portable design:** The cards can be organized into a convenient, book-like format by punching a hole in the top left corner and securing them with a key ring.

How to Use:

- **Preparation:** Print and laminate all the cards for durability. Cut them apart to create individual cards.
- **Setup:** Punch a hole in the top left corner of each card and secure them together with a key ring or pipe cleaner to keep them organized and portable.
- **Activity:** Children can use a dry-erase marker to trace the letters on each card, following the directional arrows. After practicing, simply wipe the cards clean for repeated use.

Educational Benefits:

- **Letter recognition:** Helps children recognize and differentiate between uppercase and lowercase letters, essential for developing reading skills.
- **Handwriting practice:** Encourages proper letter formation, building foundational handwriting skills necessary for writing fluency.
- **Phonemic awareness:** Reinforces beginning sounds with autumn-themed words, aiding in the development of phonemic awareness and early reading skills.
- **Fine motor skills:** Tracing letters with a dry-erase marker promotes fine motor development, strengthening the muscles needed for writing and other tasks requiring hand coordination.
- **Memory and retention:** Repeated practice with write & wipe cards enhances memory retention and reinforces learning through repetition.

Happy Teaching :)

ALPHABET TRACING

I can

- 1 Write the letter on my card, starting at the dot and following the arrows.

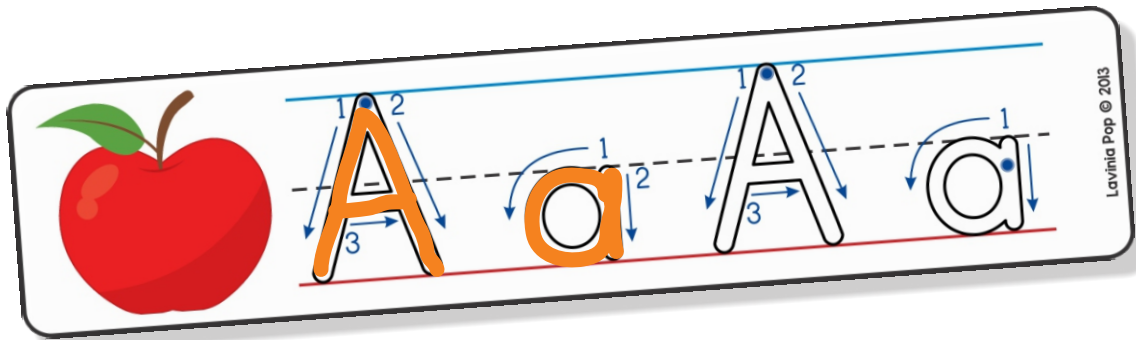

Lavinia Pop © 2013

AUTUMN

Alphabet Tracing

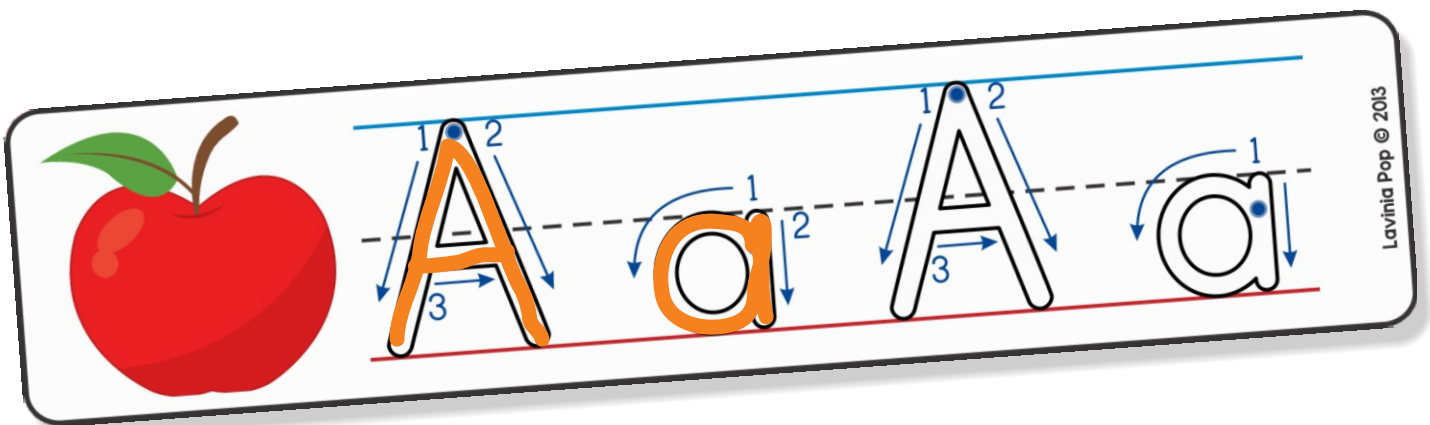

Lavinia Pop © 2013

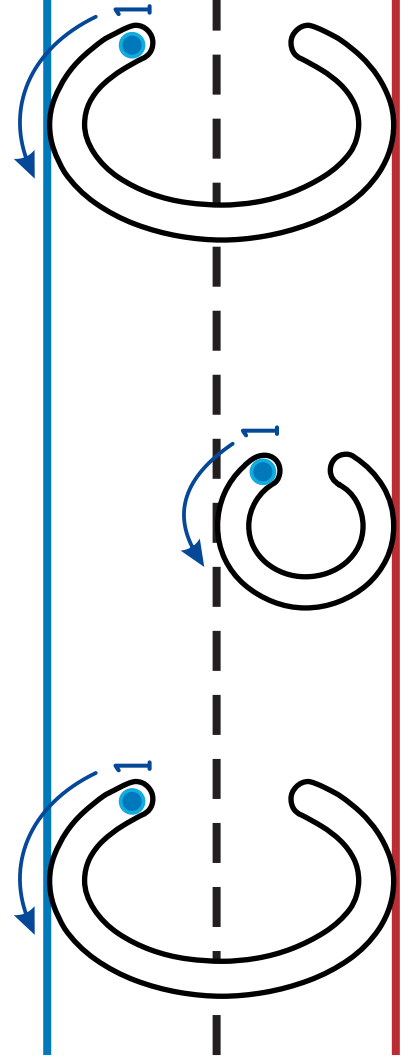
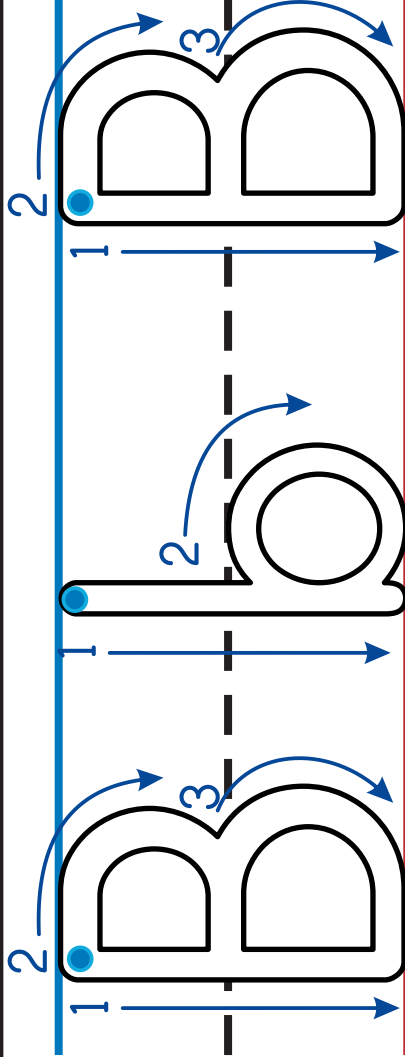
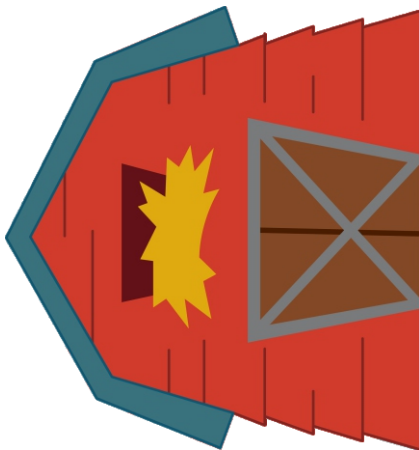
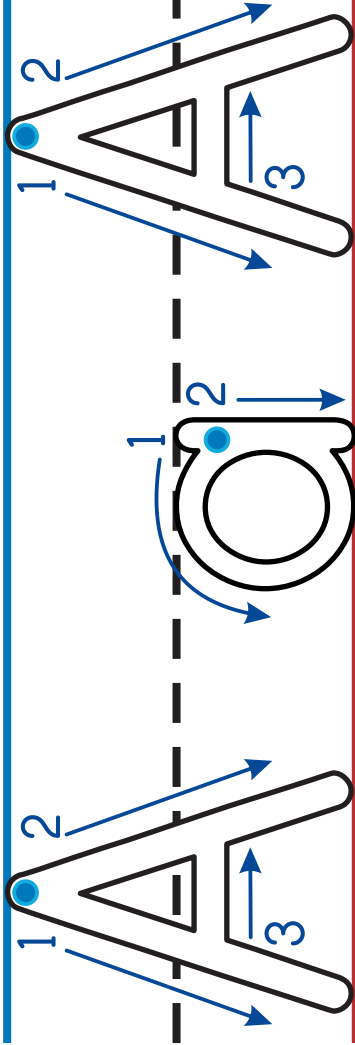
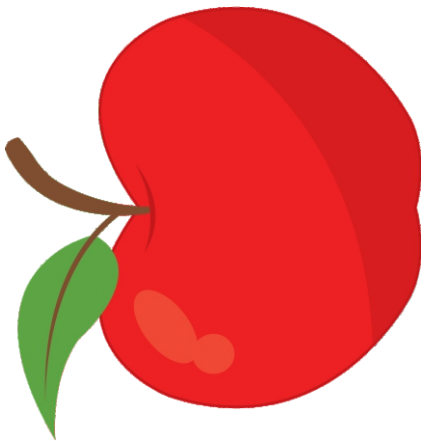

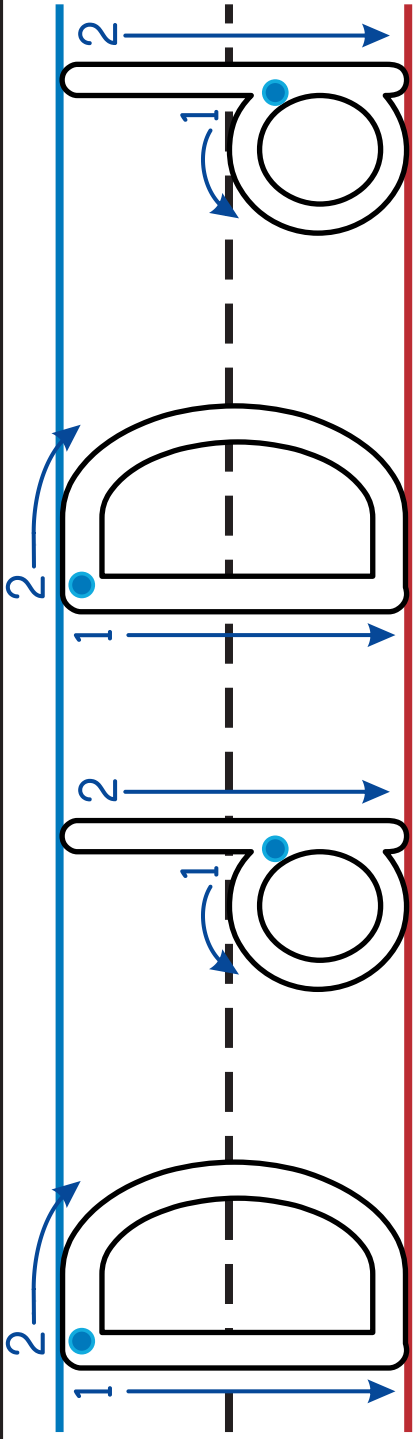
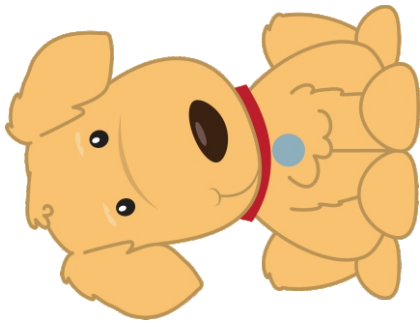

Lavinia Pop © 2013

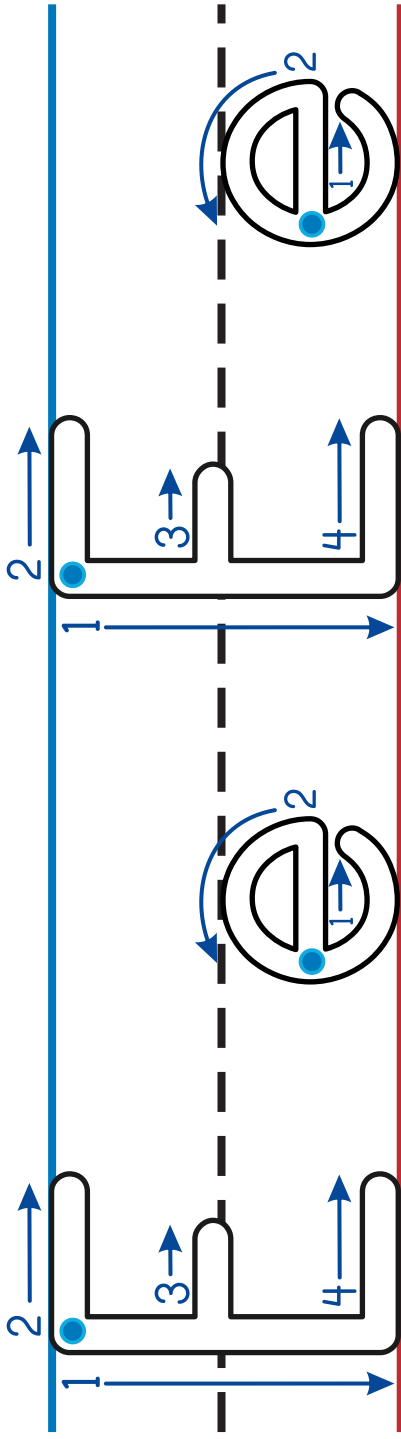
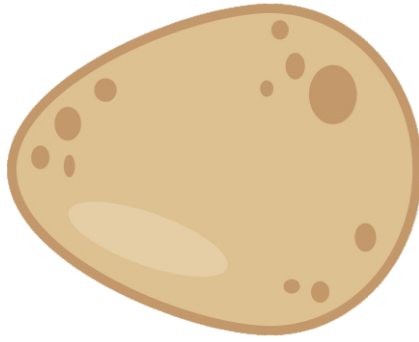

Lavinia Pop © 2013

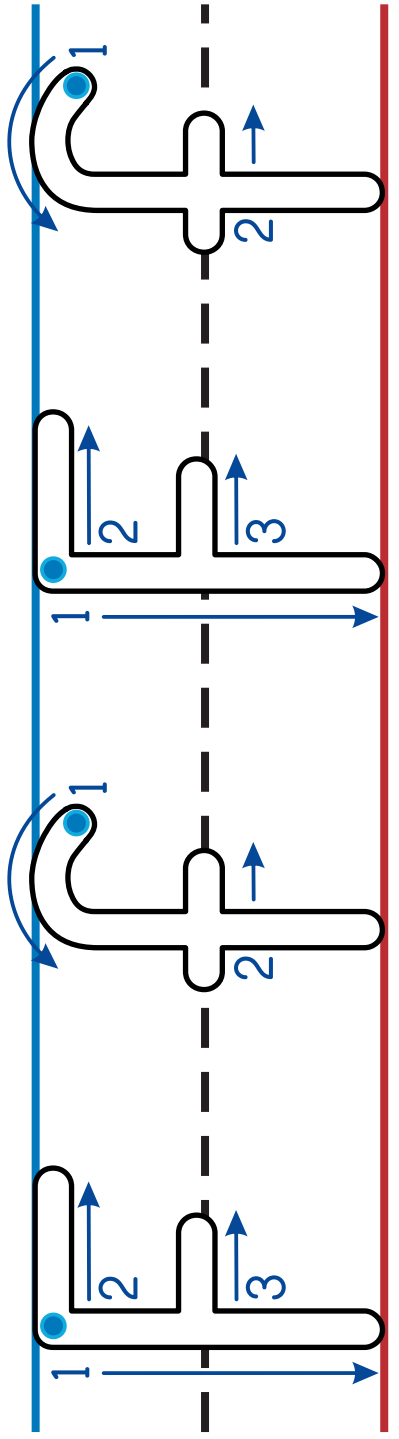
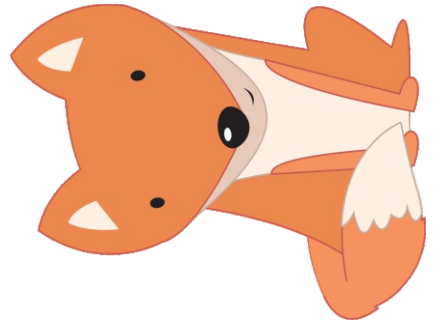

Lavinia Pop © 2013