

fire safety alphabet

TRACING CARDS

upper and lower case letters with correct letter formation

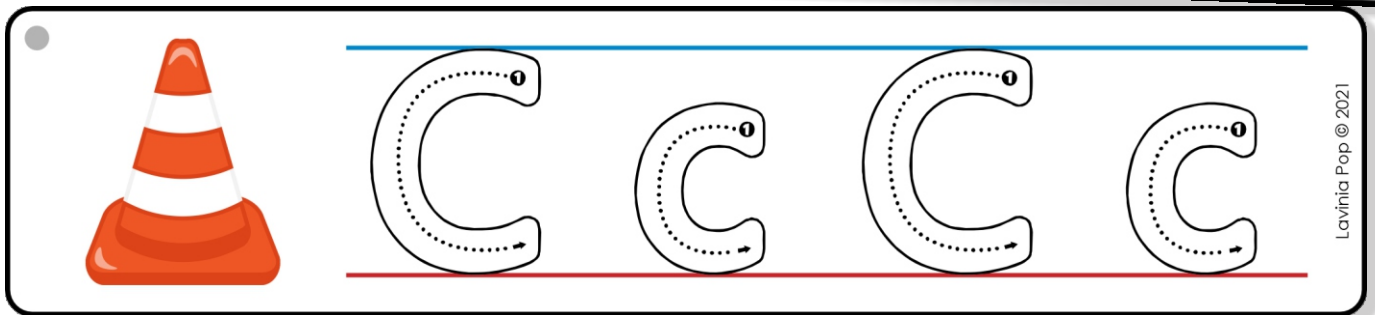

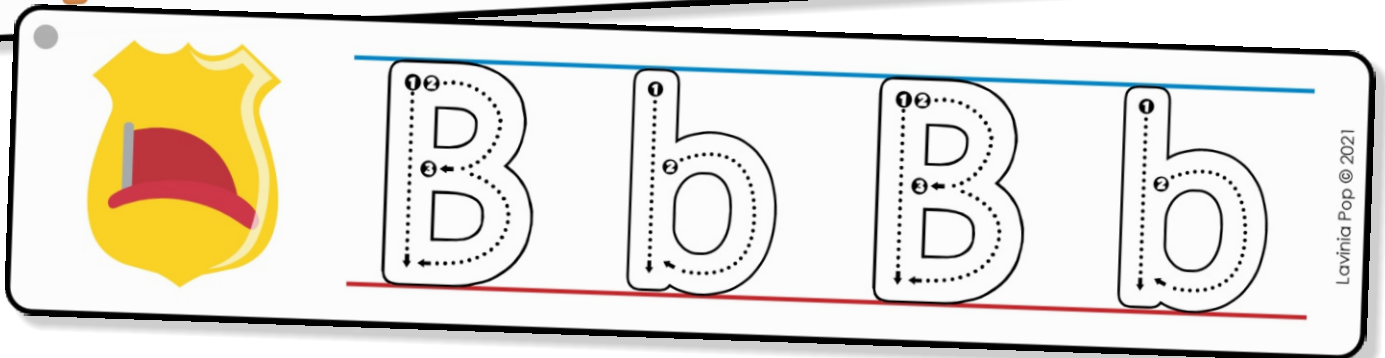
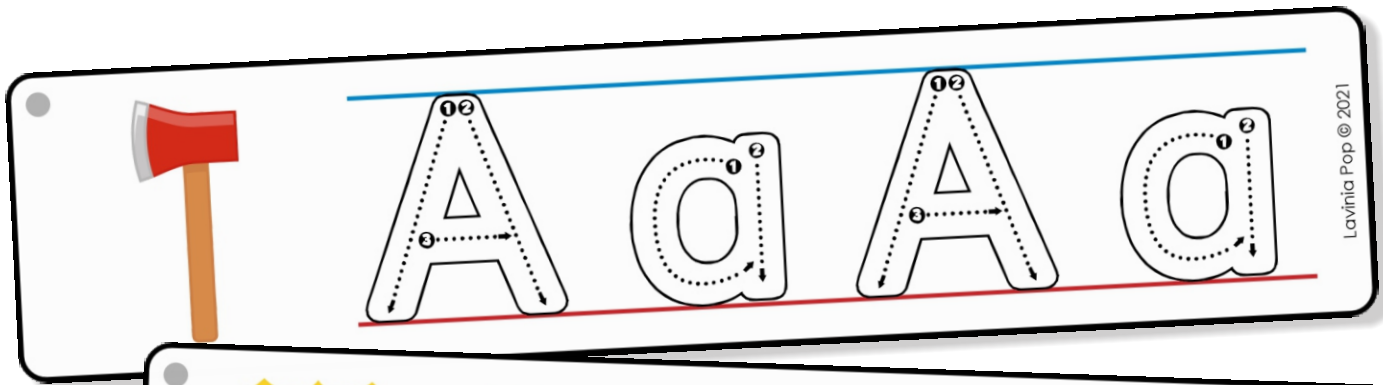
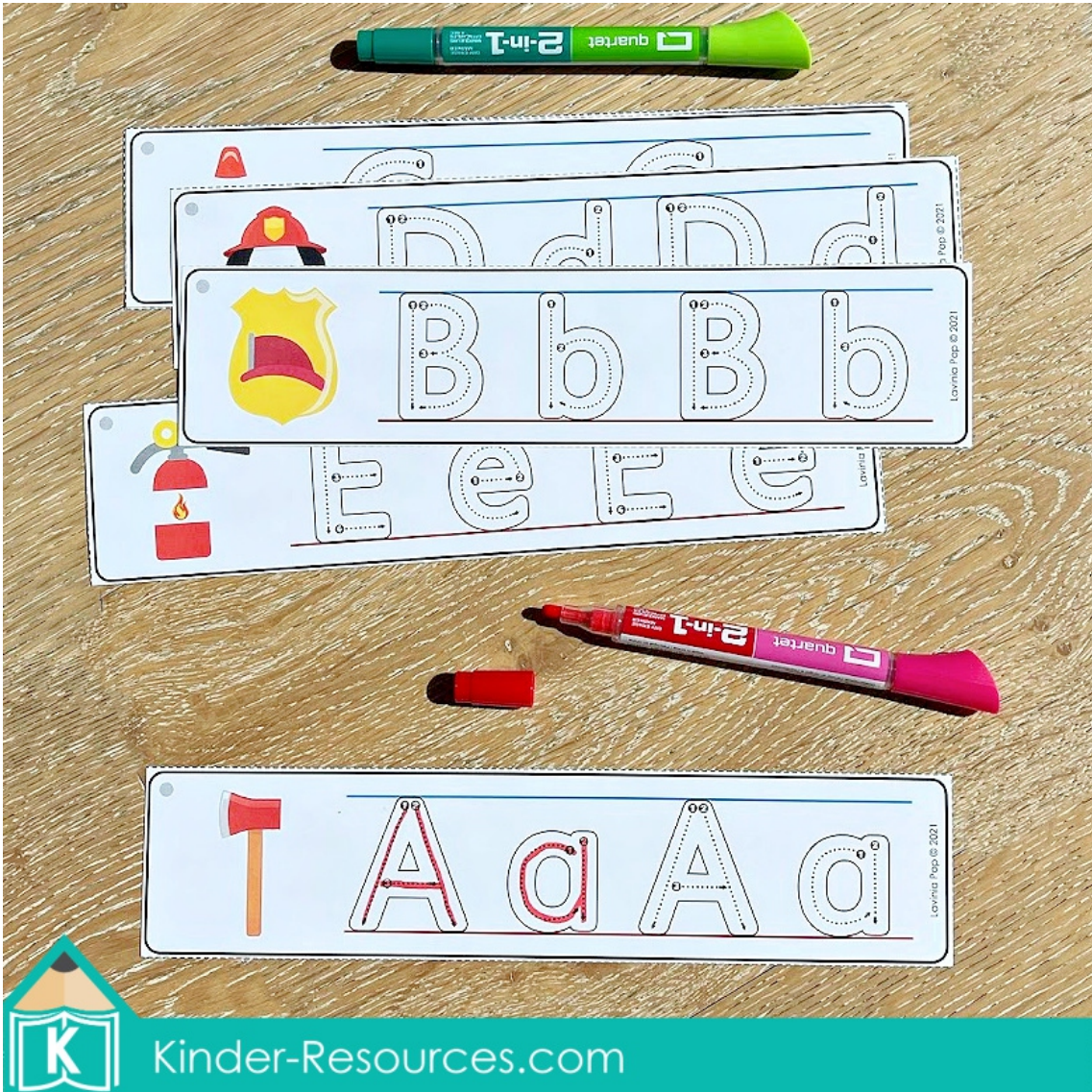

Kinder-Resources.com

Thank you for downloading this product; I hope you will enjoy using it and that it will be a valuable resource for you! I value your feedback, so please don't hesitate to contact me if you have any concerns whatsoever as I will endeavour to address them. And if you like what I've done, please let me know by leaving feedback at my online store :)

Lavinia

lavinia@kinder-resources.com

ILLUSTRATIONS Kari Bolt, Little Red, Hidesy's Clipart, Dancing Crayon Designs, Whimsy Clips, PartyHead Graphics, Ramona Majdis, Zip-a-Dee-doo-dah-Designs, Bunny on a Cloud, Krista Wallden - Creative Clips, Creating4 the Classroom, Rainbow Sprinkle Studio - Sasha Mitten, First Class Clipart, Erin Colleen Design

teacherspayteachers.com/Store/Kari-Bolt teacherspayteachers.com/Store/Littered teacherspayteachers.com/Store/Hidesys-Clipart
dancingcrayon.com teacherspayteachers.com/Store/Whimsy-Clips teacherspayteachers.com/StorePartyhead-Graphics
teacherspayteachers.com/Store/Ramona-Majdis teacherspayteachers.com/Store/Zip-a-dee-doo-dah-Designs
teacherspayteachers.com/Store/Bunny-On-A-Cloud teacherspayteachers.com/Store/Krista-Wallden-Creative-Clips
teacherspayteachers.com/Store/Creating4-The-Classroom teacherspayteachers.com/Store/Rainbow-Sprinkle-Studio-Sasha-Mitten
teacherspayteachers.com/Store/First-Class-Clipart teacherspayteachers.com/Store/Erin-Colleen-Design

This packet contains Images used under license from Shutterstock.com

FONTS schoolfonts.com.au teacherspayteachers.com/Store/Kimberly-Geswein-Fonts
teacherspayteachers.com/Store/Ramonam-Graphics

PRINTING TIP This resource has been designed for printing on A4-sized paper. If you are printing on a different size, select "shrink to printable area" or "print to fit page" (or a similar option) in order for the contents of this unit to print correctly.

Copyright © 2021 by Lavinia Pop - All rights reserved by author.

Purchase of this item entitles the purchaser the right to reproduce the pages for personal and classroom use. Duplication for other classes, an entire school or commercial purposes is strictly prohibited without written permission from the author. Minor editing is permitted only for personal use, however the document remains under copyright even when edited. Posting this item in whole or in part on the Internet in any form is strictly prohibited and is a violation of the Digital Millennium Copyright Act (DMCA).

Please be fair and don't share! If you are not the original purchaser of this file, please visit my store to purchase a copy. Kinder-Resources.com

let's connect!



Kinder-Resources.com



facebook.com/KinderResources



instagram.com/laviniapop_kinder_resources



pinterest.com/laviniapop

INTRODUCTION

Make letter formation practice fun and engaging with the **Fire Safety Alphabet Tracing Cards**! This hands-on resource helps children develop correct letter formation using a dry-erase marker and includes a fire-safety theme to keep learners excited about writing.

What's Included:

- **26 write-and-wipe alphabet cards:** Each card displays an uppercase and lowercase letter with directional arrows to guide proper formation.

How to Use:

- **Materials needed:** Dry-erase marker, whiteboard eraser.
- **Setup:** Print, laminate, and cut out each card for durability. To keep the cards organized, punch a hole in the top left corner and secure them with a key ring or pipe cleaner.
- **Activity:** Children trace the letters using a dry-erase marker, following the arrows for correct letter formation. The laminated cards can be wiped clean and used again for repeated practice.

Educational Benefits:

- **Letter formation:** Strengthens fine motor skills and helps children practice writing both uppercase and lowercase letters correctly.
- **Interactive learning:** Provides a tactile, engaging way to reinforce alphabet recognition and letter writing.
- **Reusability:** Laminated cards allow for repeated practice, making them a versatile tool in literacy centers or individual practice.

Perfect for literacy centers, handwriting practice, or small group activities, this fire-safety-themed alphabet tracing set makes learning to write letters fun and interactive!

Happy Teaching! :)

ALPHABET TRACING

I can

Write the letter on my card,
starting at dot 1 and following
the arrows.



Lavinia Pop © 2021

FIRE SAFETY

Alphabet Tracing

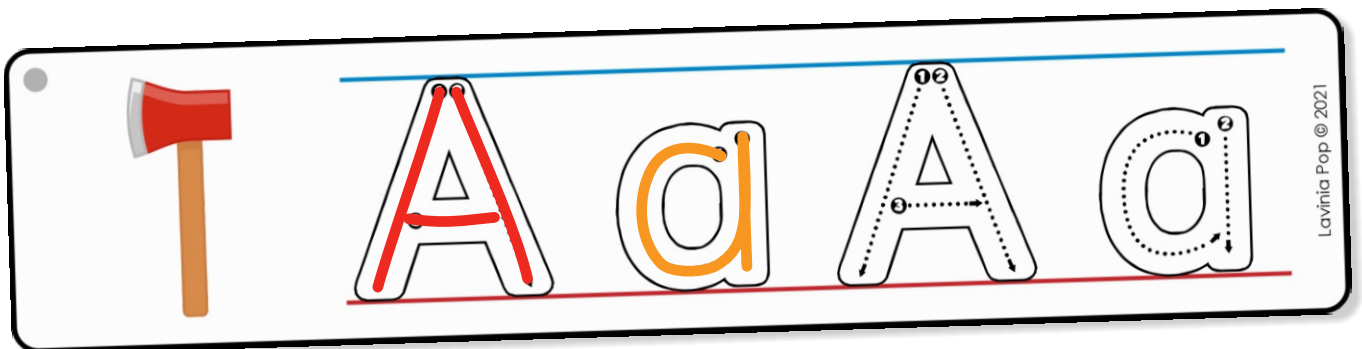

Lavinia Pop © 2021

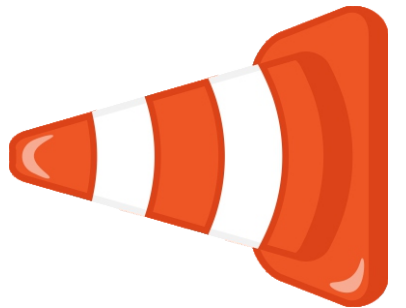
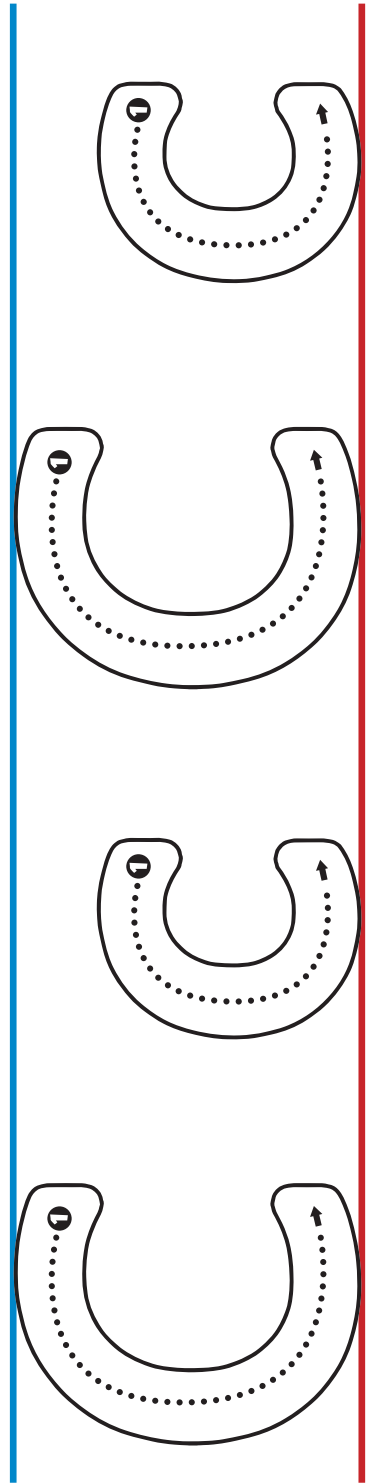
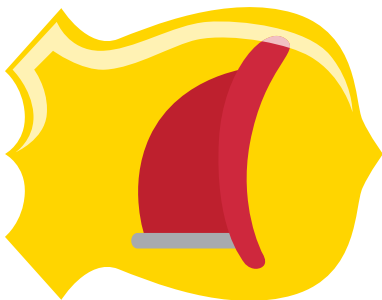
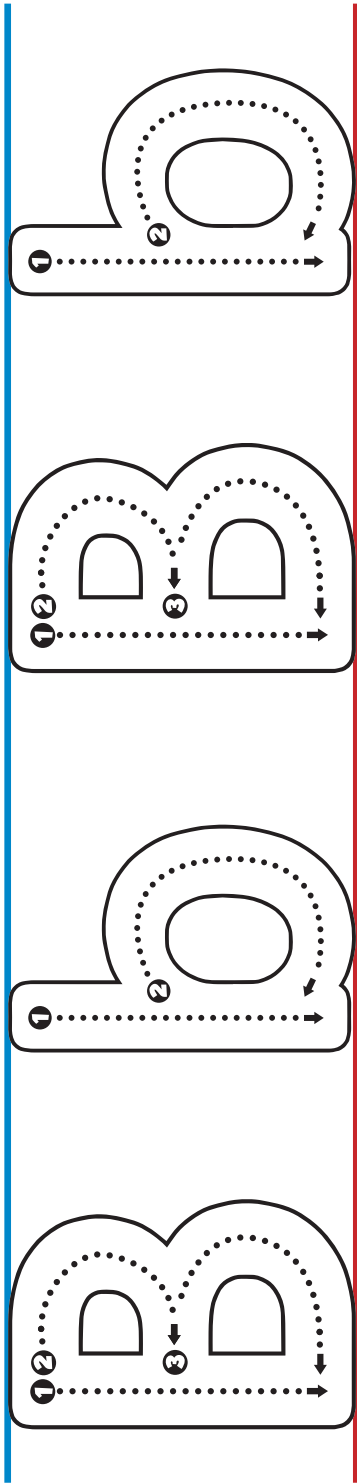
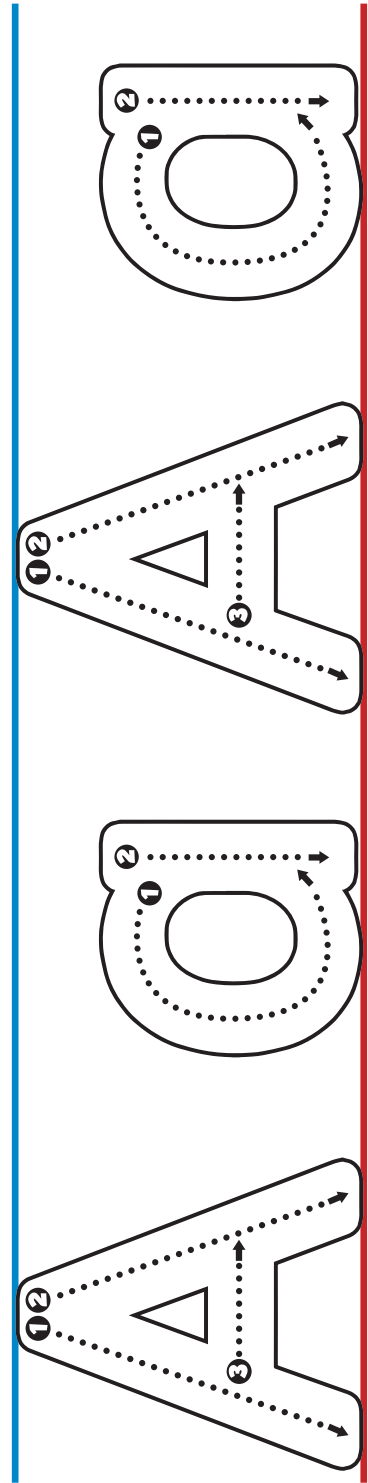

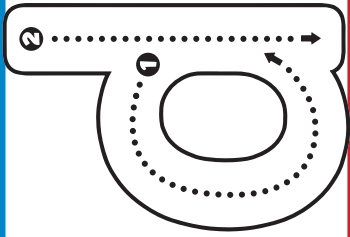
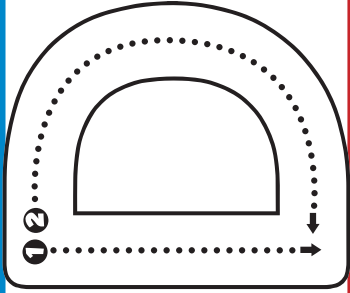
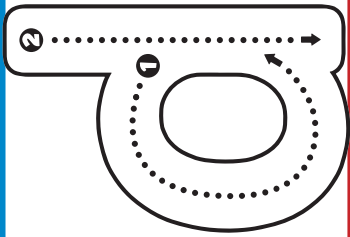
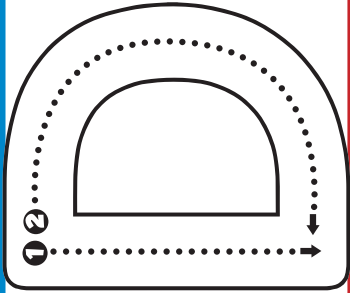

Lavinia Pop © 2021

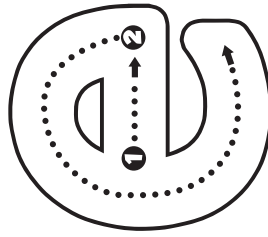
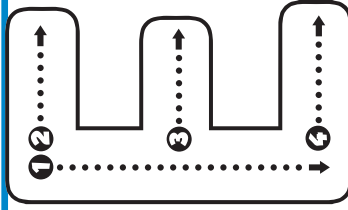
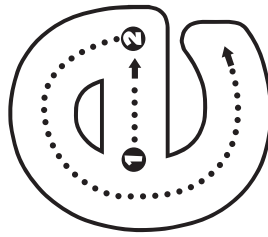
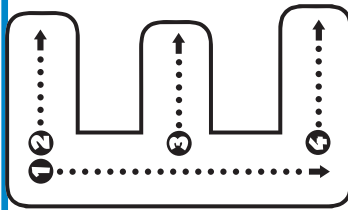
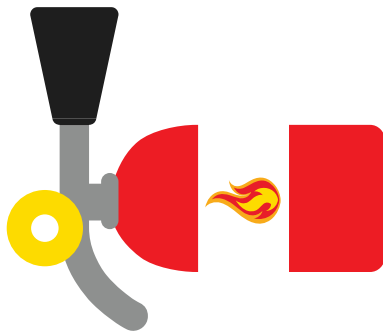

Lavinia Pop © 2021

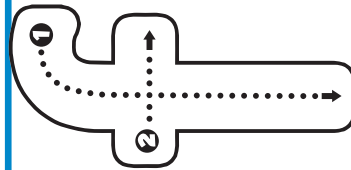
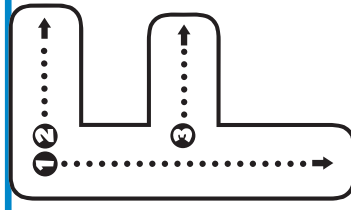
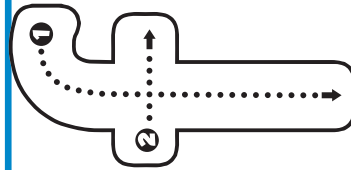
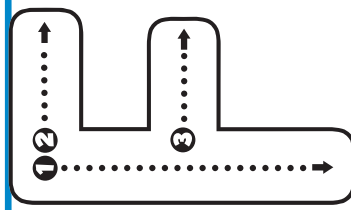
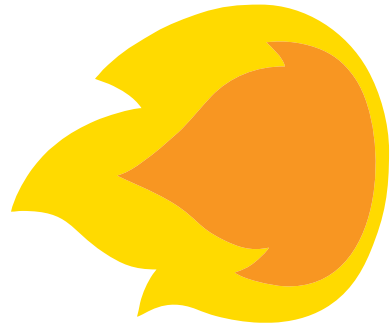

Lavinia Pop © 2021

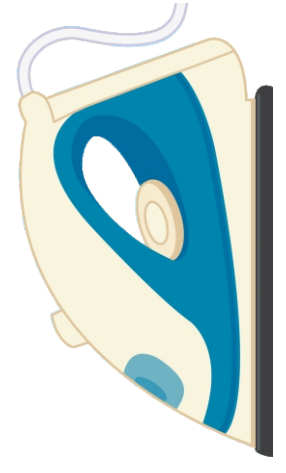
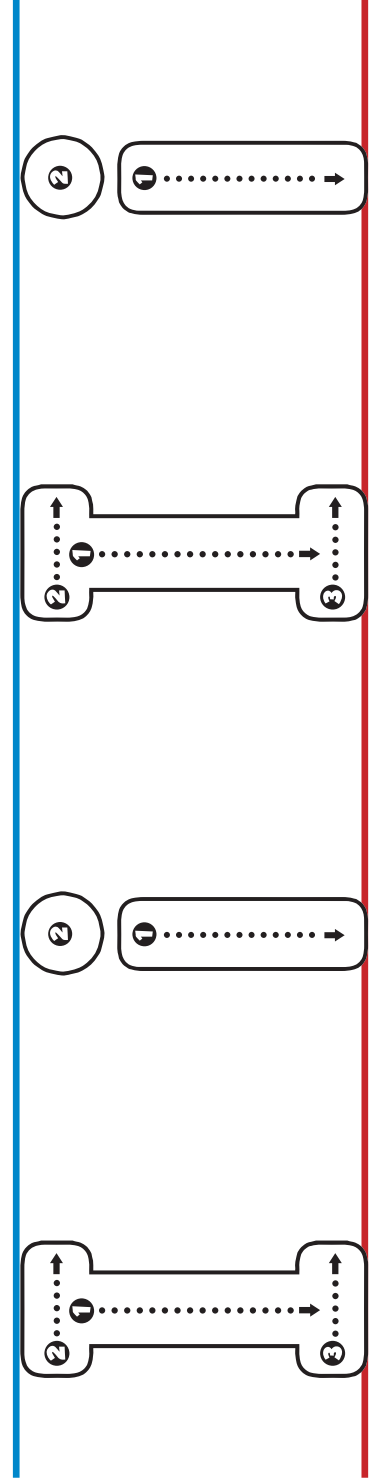
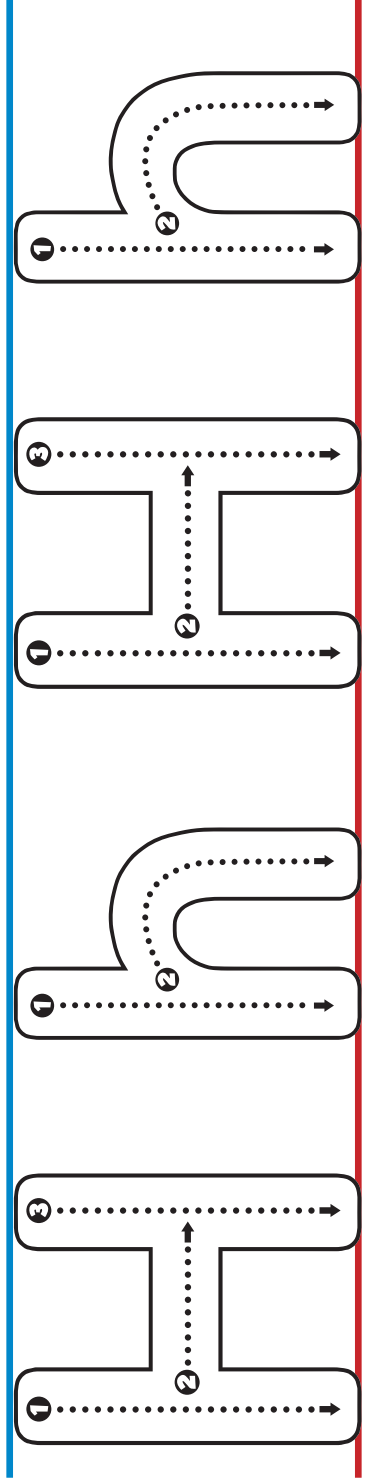
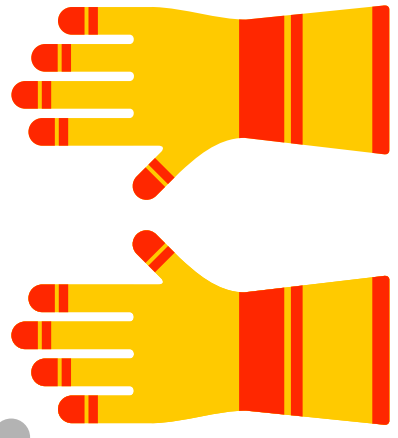
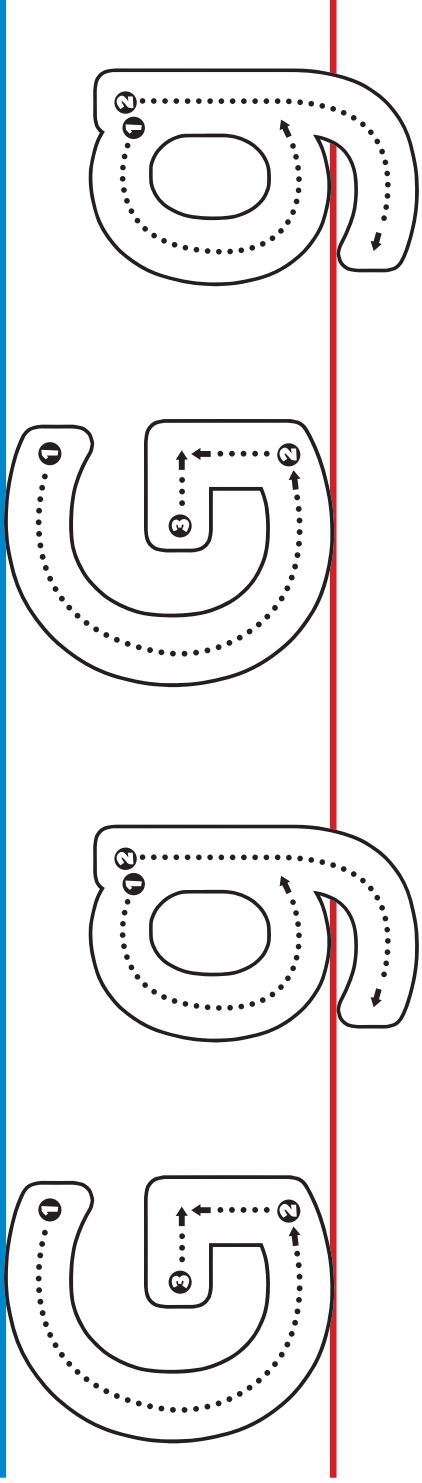

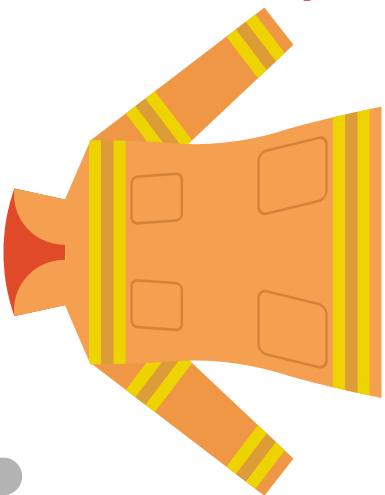
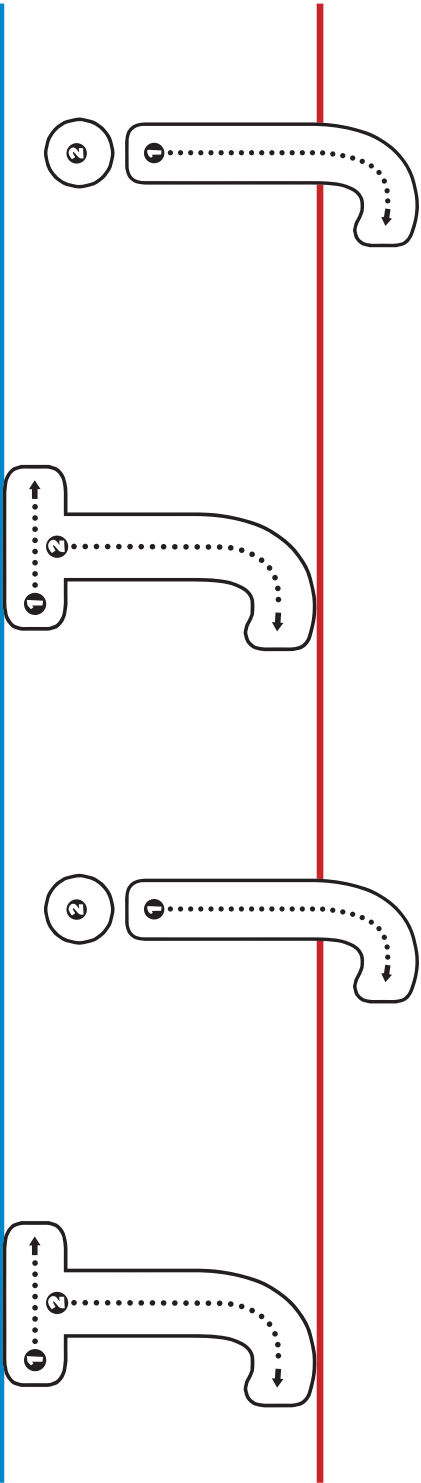
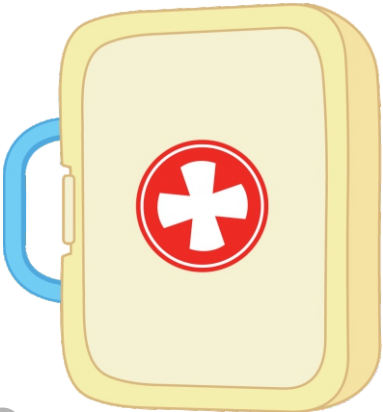
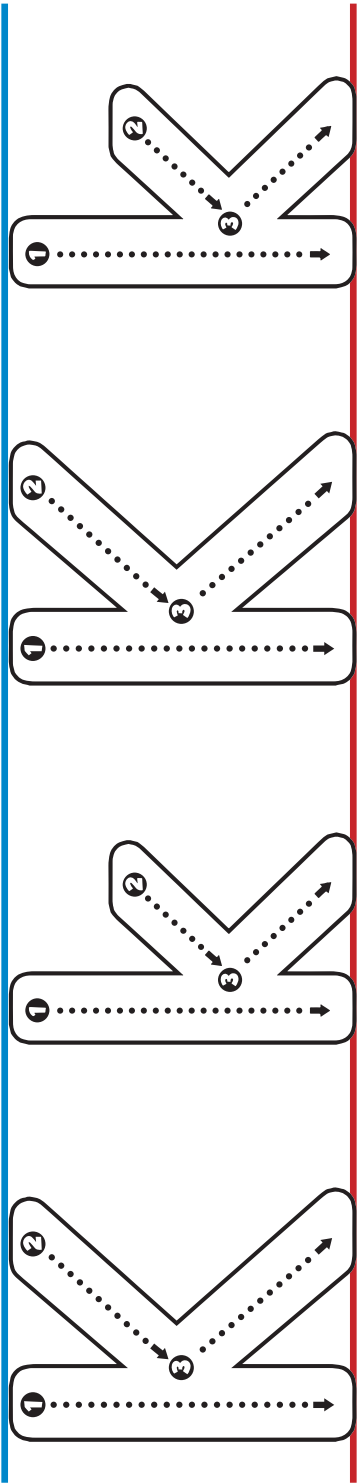
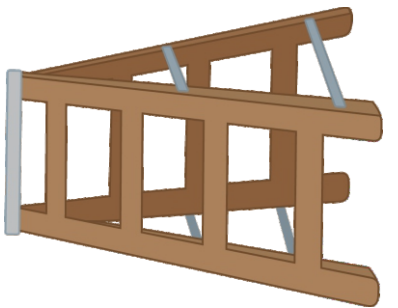
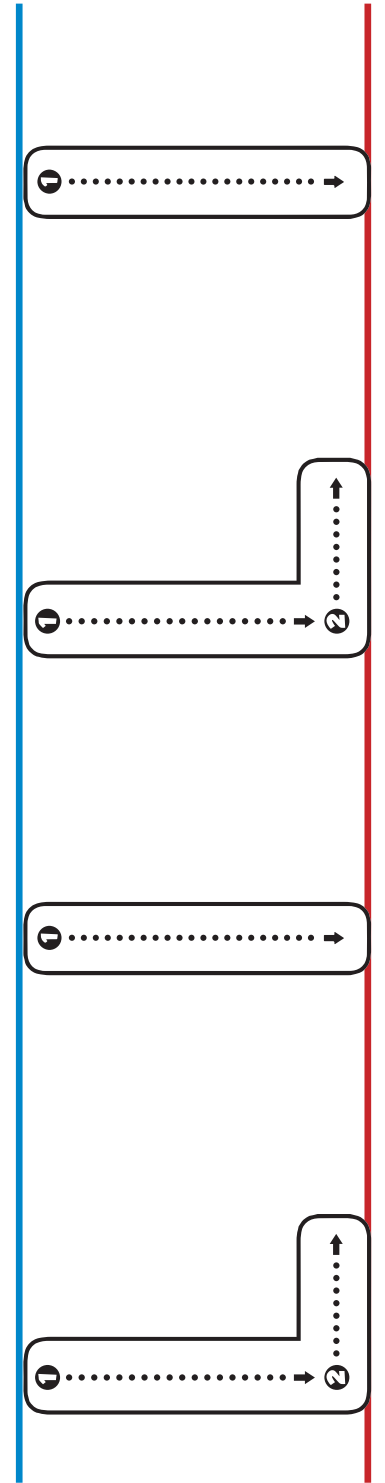

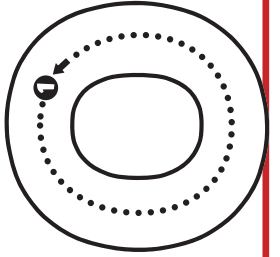
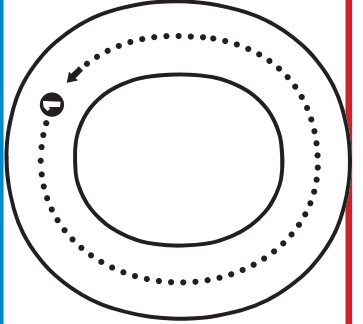
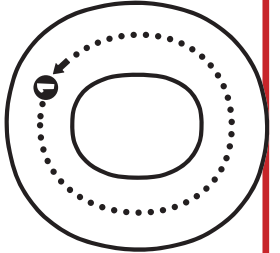
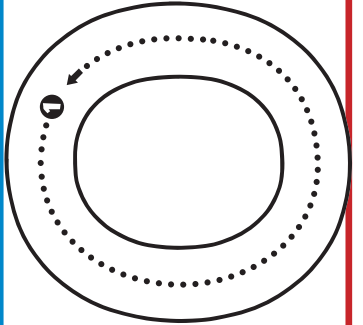
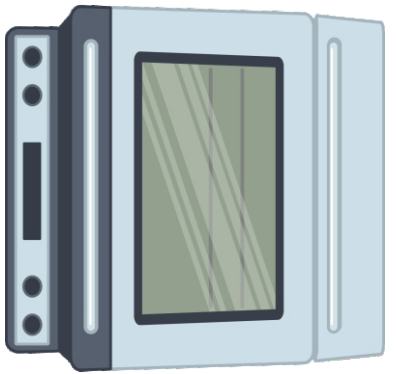
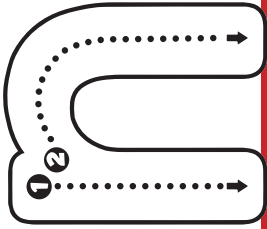
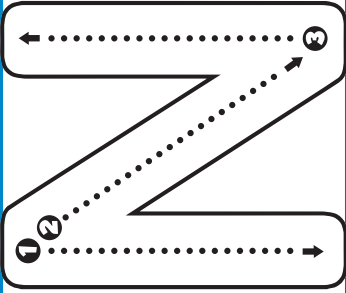
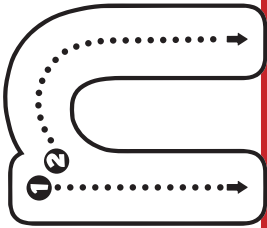
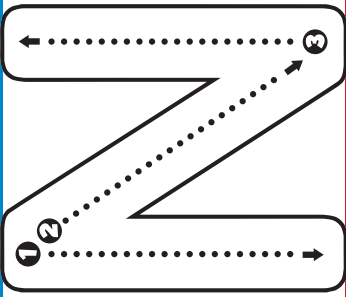
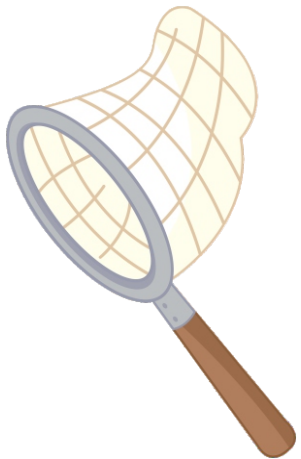
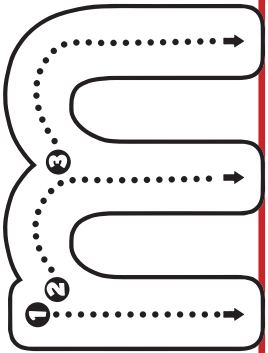
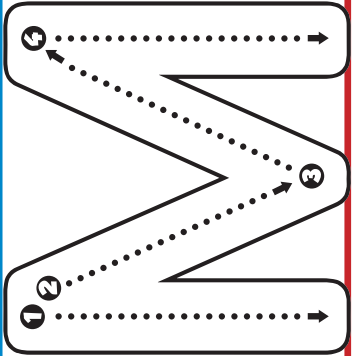
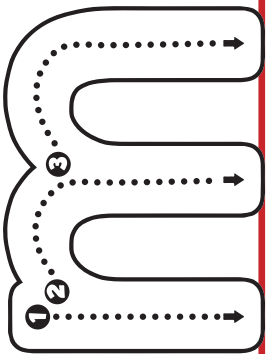
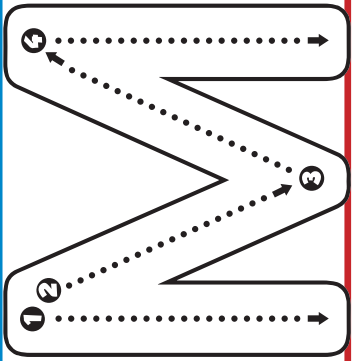
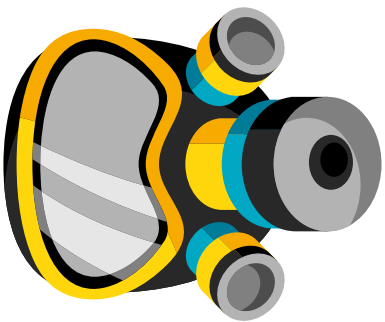

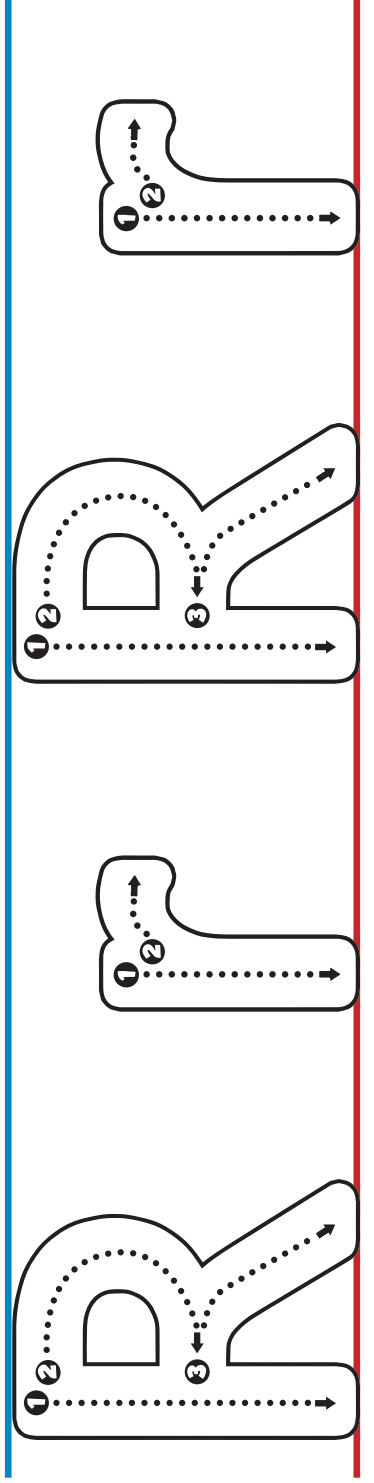
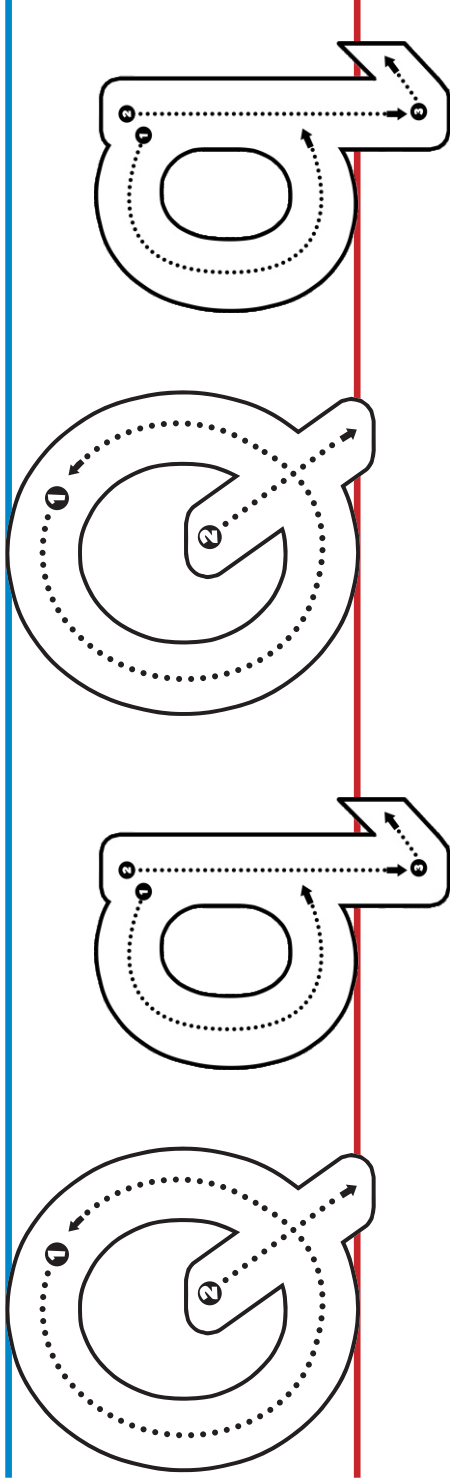
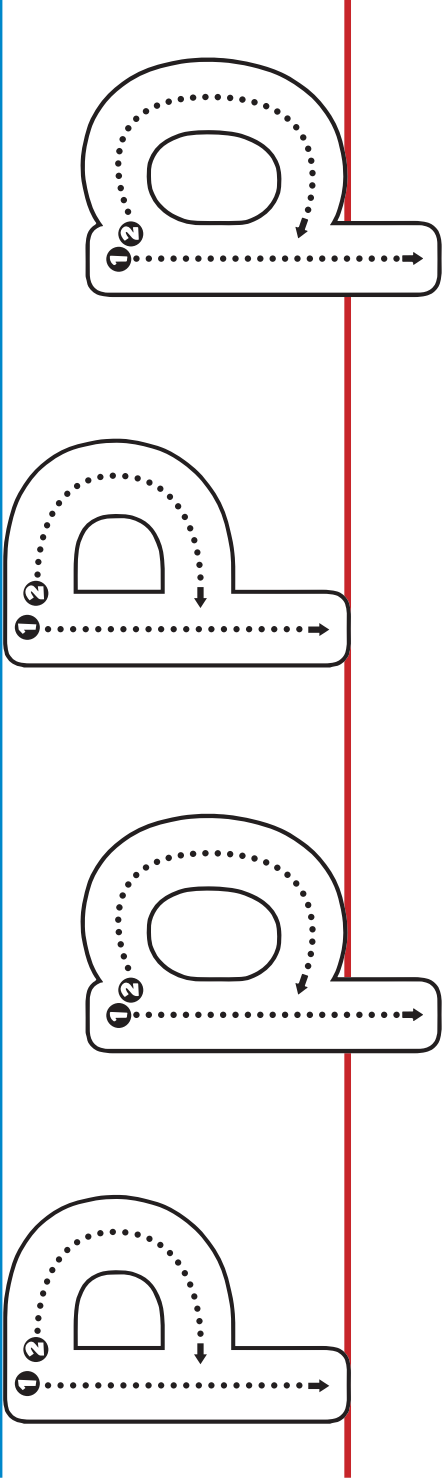

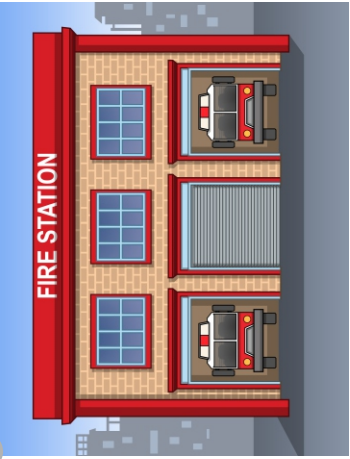
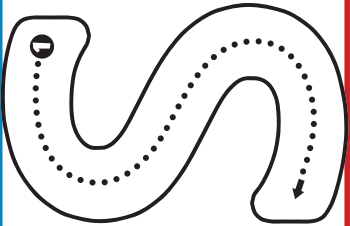
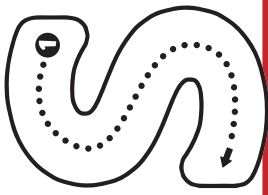
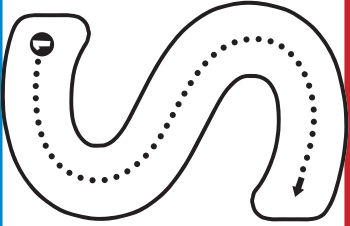
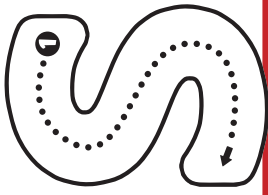
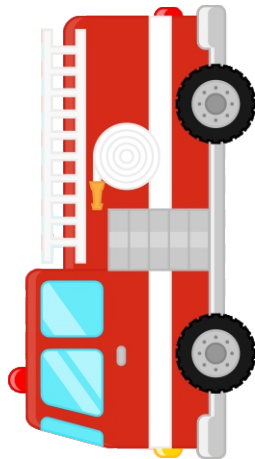
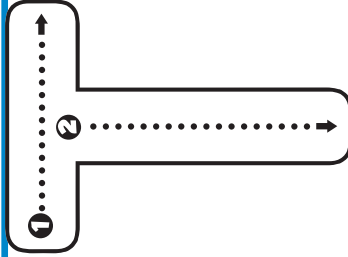
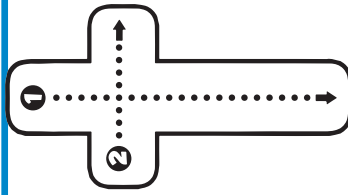
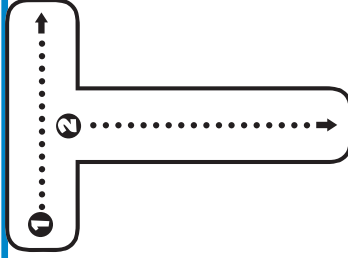
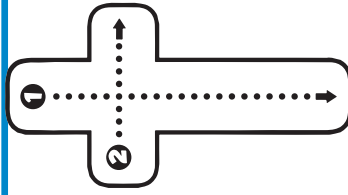
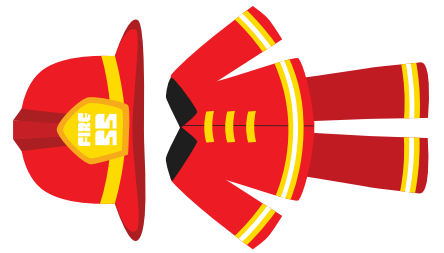
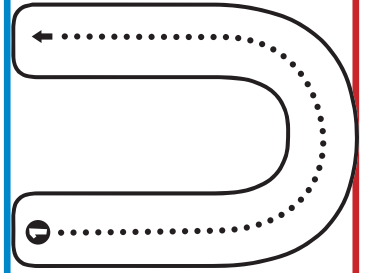
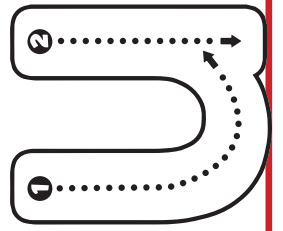
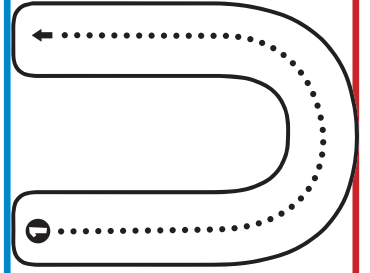
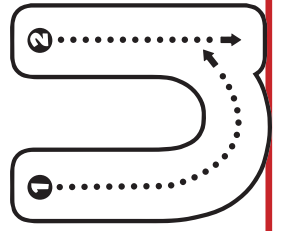

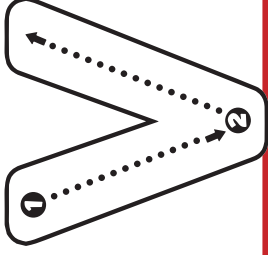
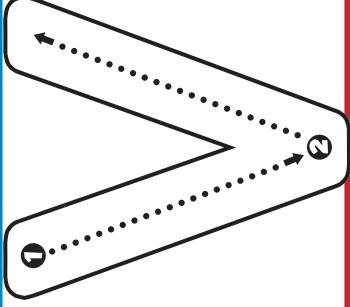
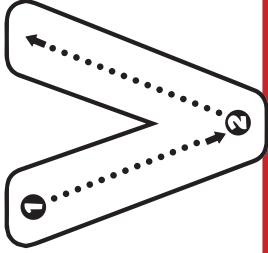
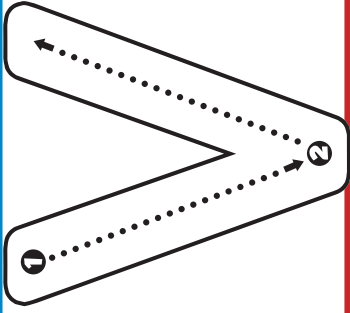
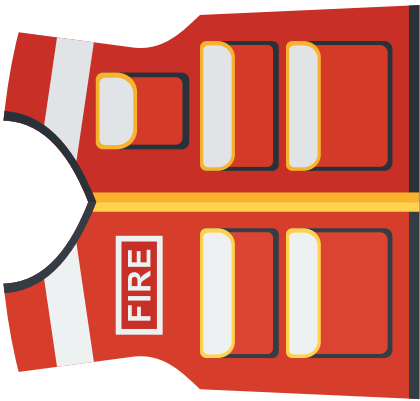

Lavinia Pop © 2021

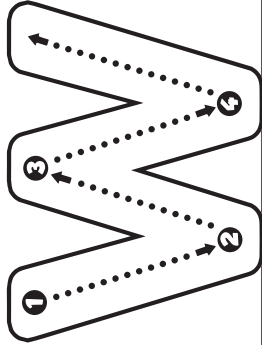
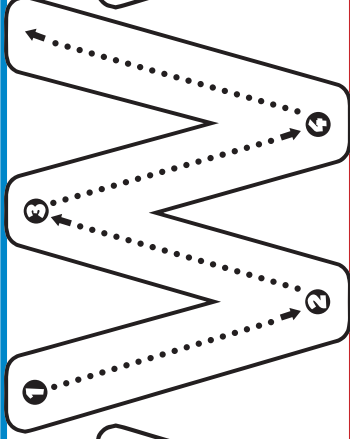
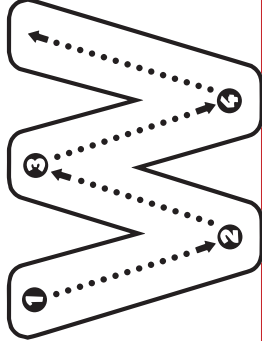
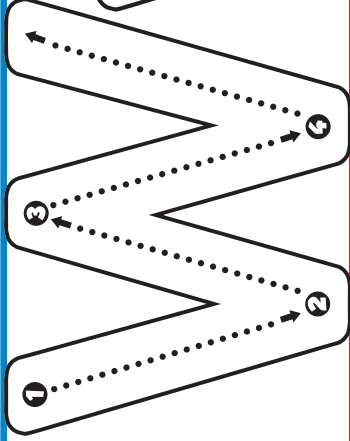
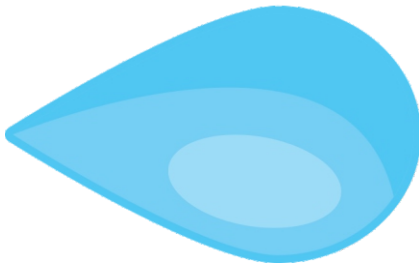

Lavinia Pop © 2021

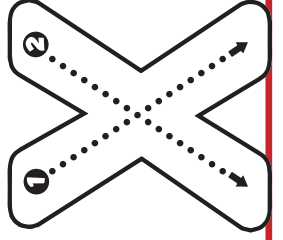
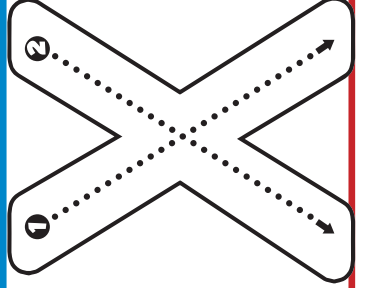
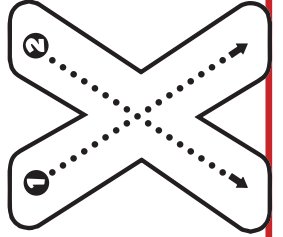
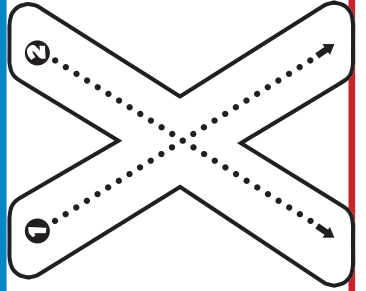
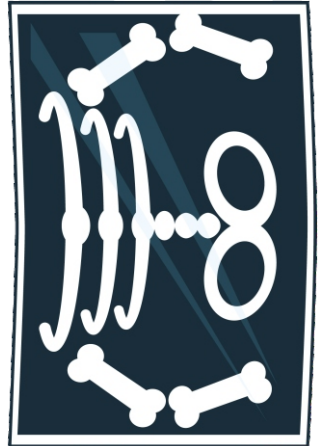

Lavinia Pop © 2021

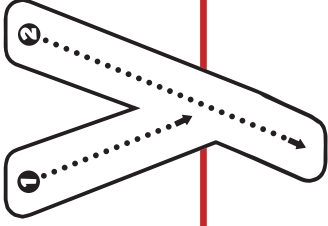
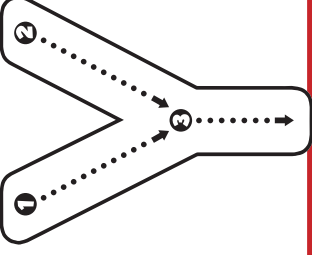
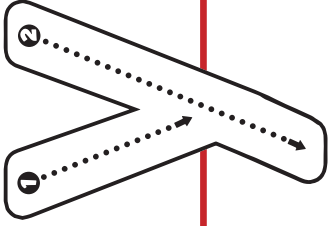
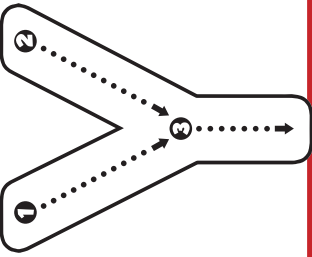
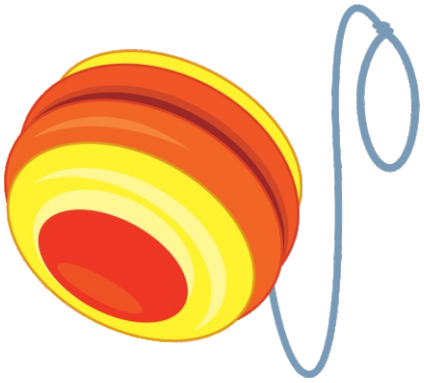

Lavinia Pop © 2021

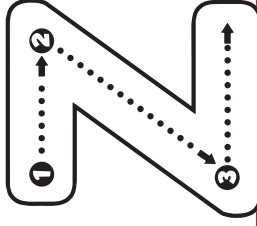
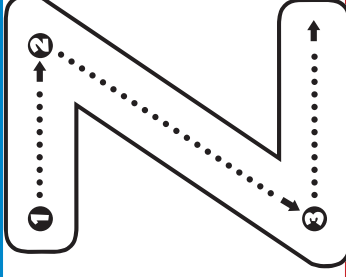
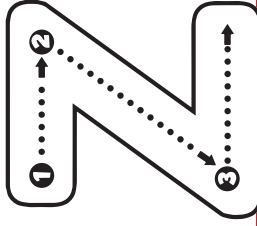
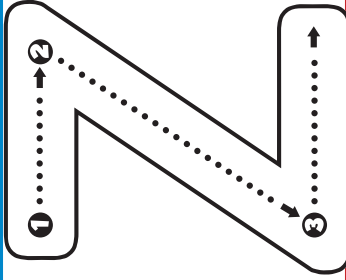
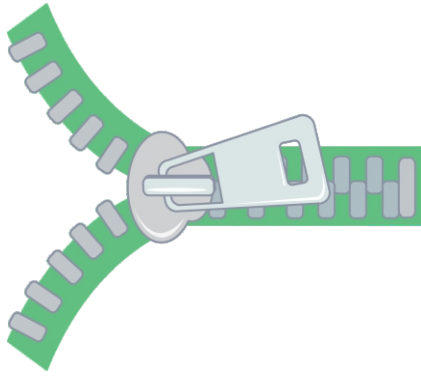

Lavinia Pop © 2021

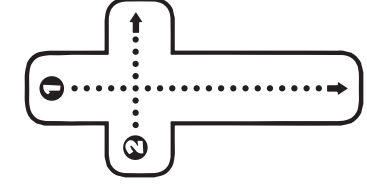
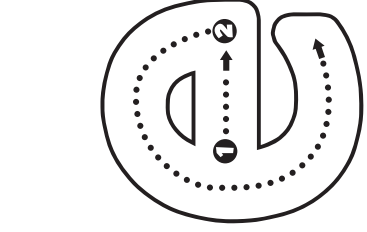
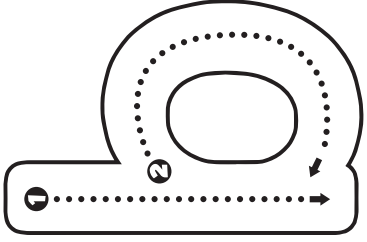
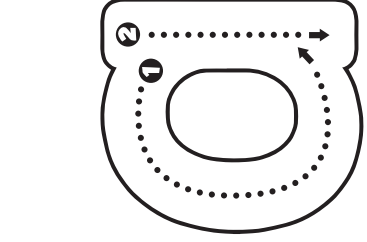
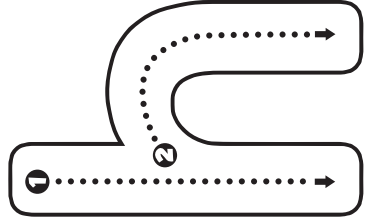
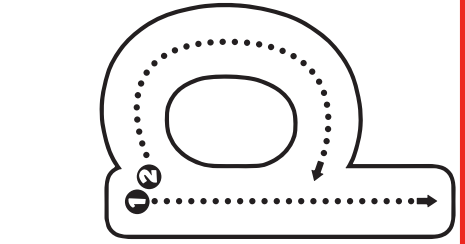

Lavinia Pop © 2021

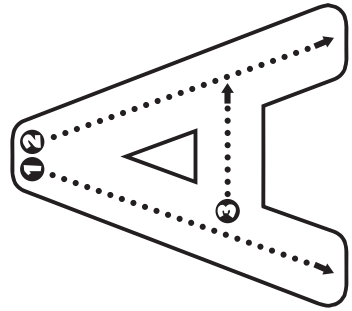

with correct formation